



Pumping&Plumbing

Schedule 80 CPVC Technical Information
Schedule 80 CPVC Fittings

ASTM STANDARD DIMENSIONS

**SCHEDULE 80 PIPE DIMENSIONS
 ASTM D 1785**

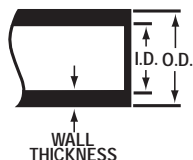

| Nominal Pipe Size In. | Mean Outside Diameter In. | O. D. Tolerance In. | Minimum Wall Thickness In. |
|-----------------------|---------------------------|---------------------|----------------------------|
| 1/8 | 0.405 | ± 0.004 | 0.095 |
| 1/4 | 0.540 | ± 0.004 | 0.119 |
| 3/8 | 0.675 | ± 0.004 | 0.126 |
| 1/2 | 0.840 | ± 0.004 | 0.147 |
| 3/4 | 1.050 | ± 0.004 | 0.154 |
| 1 | 1.315 | ± 0.005 | 0.179 |
| 1-1/4 | 1.660 | ± 0.005 | 0.191 |
| 1-1/2 | 1.900 | ± 0.006 | 0.200 |
| 2 | 2.375 | ± 0.006 | 0.218 |
| 2-1/2 | 2.875 | ± 0.007 | 0.276 |
| 3 | 3.500 | ± 0.008 | 0.300 |
| 4 | 4.500 | ± 0.009 | 0.337 |
| 5 | 5.563 | ± 0.010 | 0.375 |
| 6 | 6.625 | ± 0.011 | 0.432 |
| 8 | 8.625 | ± 0.015 | 0.500 |
| 10 | 10.750 | ± 0.015 | 0.593 |
| 12 | 12.750 | ± 0.015 | 0.687 |

**SCHEDULE 80 SOCKET DIMENSIONS
 ASTM D 2467**

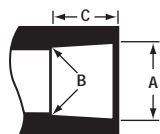

| Nominal Size In. | Diameter | | | Socket Length Minimum C |
|------------------|------------|----------|-------------|-------------------------|
| | Entrance A | Bottom B | Tolerance A | |
| 1/8 | 0.417 | 0.401 | ± 0.004 | 0.500 |
| 1/4 | 0.552 | 0.536 | ± 0.004 | 0.625 |
| 3/8 | 0.687 | 0.671 | ± 0.004 | 0.750 |
| 1/2 | 0.848 | 0.836 | ± 0.004 | 0.875 |
| 3/4 | 1.058 | 1.046 | ± 0.004 | 1.000 |
| 1 | 1.325 | 1.310 | ± 0.005 | 1.125 |
| 1-1/4 | 1.670 | 1.655 | ± 0.005 | 1.250 |
| 1-1/2 | 1.912 | 1.894 | ± 0.006 | 1.375 |
| 2 | 2.387 | 2.369 | ± 0.006 | 1.500 |
| 2-1/2 | 2.889 | 2.868 | ± 0.007 | 1.750 |
| 3 | 3.516 | 3.492 | ± 0.008 | 1.875 |
| 4 | 4.518 | 4.491 | ± 0.009 | 2.250 |
| 5 | 5.583 | 5.553 | ± 0.010 | 2.625 |
| 6 | 6.647 | 6.614 | ± 0.011 | 3.000 |
| 8 | 8.655 | 8.610 | ± 0.015 | 4.000 |
| 10 | 10.780 | 10.735 | ± 0.015 | 5.000 |
| 12 | 12.780 | 12.735 | ± 0.015 | 6.000 |
| 14 | 14.030 | 13.985 | ± 0.015 | 7.000 |

**AMERICAN NATIONAL STANDARD
 TAPER PIPE THREADS (NPT) ANSI
 B1 .20.1 ASTM F 1498**

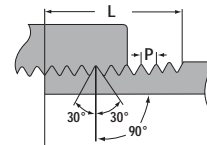

| Nominal Size In. | Threads Per Inch | Effective Thread Length L | Pitch Of Thread P |
|------------------|------------------|---------------------------|-------------------|
| 1/8 | 27 | 0.2639 | 0.03704 |
| 1/4 | 18 | 0.4018 | 0.05556 |
| 3/8 | 18 | 0.4078 | 0.05556 |
| 1/2 | 14 | 0.5337 | 0.07143 |
| 3/4 | 14 | 0.5457 | 0.07143 |
| 1 | 11-1/2 | 0.6828 | 0.08696 |
| 1-1/4 | 11-1/2 | 0.7068 | 0.08696 |
| 1-1/2 | 11-1/2 | 0.7235 | 0.08696 |
| 2 | 11-1/2 | 0.7565 | 0.08696 |
| 2-1/2 | 8 | 1.1375 | 0.12500 |
| 3 | 8 | 1.2000 | 0.12500 |
| 4 | 8 | 1.3000 | 0.12500 |
| 5 | 8 | 1.4063 | 0.12500 |
| 6 | 8 | 1.5125 | 0.12500 |
| 8 | 8 | 1.7125 | 0.12500 |

STANDARD COMPARISONS

SPEARS® IPS-to-Metric transition unions are listed by nominal size. The chart below compares nominal and actual* pipe O.D. for each size according to the designated standard.

| JIS K6741 (mm) | | DIN 8062 (mm) | | ASTM D1785 (in.) | | NPT—ANSI B1.20.1** Tapered Thread | | BSP—BS21, DIN 2999, ISO 7/1 Thread | |
|----------------|---------|---------------|---------|------------------|---------|-----------------------------------|-------------|------------------------------------|----------------|
| Nominal | Actual* | O.D. | Actual* | Nominal | Actual* | Designation | Threads/in. | Designation | Threads/25.4mm |
| 16 | 22 | 15 | 20 | 1/2 | .840 | 1/2 | 14 | 1/2 | 14 |
| 20 | 26 | 20 | 25 | 3/4 | 1.050 | 3/4 | 14 | 3/4 | 14 |
| 25 | 32 | 25 | 32 | 1 | 1.315 | 1 | 11.5 | 1 | 11 |
| 30 | 38 | 38 | 40 | 1-1/4 | 1.660 | 1-1/4 | 11.5 | 1-1/4 | 11 |
| 40 | 48 | 40 | 50 | 1-1/2 | 1.900 | 1-1/2 | 11.5 | 1-1/2 | 11 |
| 50 | 60 | 50 | 63 | 2 | 2.375 | 2 | 11.5 | 2 | 11 |
| 75 | 89 | 80 | 90 | 3 | 3.500 | 3 | 8 | 3 | 11 |
| 100 | 114 | 100 | 110 | 4 | 4.500 | 4 | 8 | 4 | 11 |

*Specified dimension, certain tolerances apply

**NPT and BSP have different thread angles and not compatible.

Schedule 80 CPVC Technical Information
Schedule 80 CPVC Fittings



Pumping&Plumbing

Injection Molded Dimensions References:

- G** = (LAYING LENGTH) intersection of center lines to bottom of socket/thread; 90° elbows, tees, crosses; ± 1/32 inch.
- H** = Intersection of center lines to face of fitting; 90° elbow tees, crosses; ± 1/32 inch.
- J** = Intersection of center lines to bottom of socket/thread; 45° elbows; ± 1/32 inch

- L** = Overall length of fittings; ± 1/16 inch.
- H** = Outside diameter of socket/thread hub; ± 1/16 inch.
- N** = Socket bottom to socket bottom; couplings; ± 1/16 inch
- W** = Height of cap; ± 1/16 inch.

Fabricated Dimension References:

- G** = (LAYING LENGTH) intersection of center lines to bottom of socket/thread; 90° elbows, tees, crosses ± 1/4 inch; 14" & larger ± 1/2 inch.
- H** = Intersection of center lines to face of fitting; 90° elbows ± 1/4 inch, 14" & larger ± 3/4 inch; wyes ± 1/2 inch; tees, crosses ± 1/4 inch; 14" & larger ± 1/2 inch.
- J** = Intersection of center lines to bottom of socket/thread; 45° elbows; ± 1/4 inch; 14" & larger ± 1/2 inch.

- L** = Overall length of fittings; ± 1/2 inch; 14" & larger ± 1 inch; wyes ± 1 inch.
- M** = Outside diameter of socket/thread hub; ± 1/4 inch.
- N** = Socket bottom to socket bottom; couplings; ± 1/2
- W** = Height of cap; ± 1/4 inch.

Typical Fabricated Dimension References

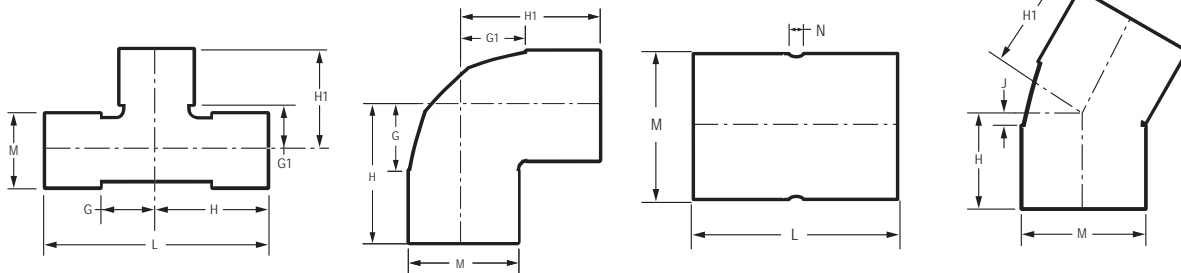

TEE

Socket x Socket x Socket

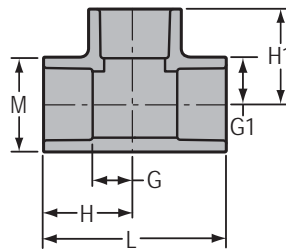

| Part Number | Size | G | G1 | H | H1 | L | M | Approx. Wt. (Lbs.) |
|-------------|-------|---------|---------|---------|---------|---------|---------|--------------------|
| 801-002C | 1/4 | 5/16 | 5/16 | 31/32 | 31/32 | 1-15/16 | 27/32 | .04 |
| 801-003C | 3/8 | 15/32 | 15/32 | 1-1/4 | 1-1/4 | 2-1/2 | 31/32 | .06 |
| 801-005C | 1/2 | 17/32 | 17/32 | 1-15/32 | 1-15/32 | 2-15/16 | 1-3/16 | .11 |
| 801-007C | 3/4 | 21/32 | 21/32 | 1-11/16 | 1-11/16 | 3-13/32 | 1-13/32 | .18 |
| 801-010C | 1 | 27/32 | 27/32 | 2 | 2 | 3-31/32 | 1-23/32 | .29 |
| 801-012C | 1-1/4 | 1-1/32 | 1-1/32 | 2-9/32 | 2-9/32 | 4-19/32 | 2-3/32 | .40 |
| 801-015C | 1-1/2 | 1-3/16 | 1-3/16 | 2-9/32 | 2-9/32 | 5-1/8 | 2-3/8 | .57 |
| 801-020C | 2 | 1-7/16 | 1-7/16 | 2-15/16 | 2-15/16 | 5-7/8 | 2-7/8 | .85 |
| 801-025C | 2-1/2 | 1-23/32 | 1-23/32 | 3-1/2 | 3-1/2 | 7 | 3-15/32 | 1.62 |
| 801-030C | 3 | 2-1/16 | 2-1/16 | 3-31/32 | 3-31/32 | 7-15/16 | 4-5/32 | 2.53 |
| 801-040C | 4 | 2-1/2 | 2-1/2 | 4-3/4 | 4-3/4 | 9-1/2 | 5-1/4 | 3.72 |



Pumping&Plumbing

Schedule 80 CPVC Technical Information
Schedule 80 CPVC Fittings

TEE (continued)
 Socket x Socket x Socket

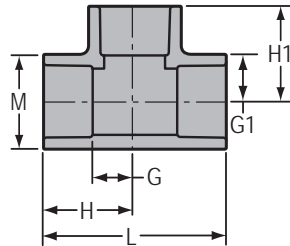

| Part Number | Size | G | G1 | H | H1 | L | M | Approx. Wt. (Lbs.) |
|-------------|------|---------|---------|----------|----------|---------|----------|--------------------|
| 801-050C | 5 | 3-1/8 | 3-1/8 | 5-25/32 | 5-25/32 | 11-5/8 | 6-13/32 | 6.47 |
| 801-050CF | 5 | 5-1/2 | 5-1/2 | 8-1/2 | 8-1/2 | 17 | 6-5/16 | 18.38 |
| 801-060C | 6 | 4-1/32 | 4-1/32 | 7-3/32 | 7-3/32 | 14-5/32 | 7-19/32 | 12.19 |
| 801-080C | 8 | 4-13/16 | 4-13/16 | 8-7/8 | 8-7/8 | 17-3/4 | 9-23/32 | 21.53 |
| 801-080CF | 8 | 7-5/8 | 7-5/8 | 11-7/8 | 11-7/8 | 23-3/4 | 9-5/8 | 30.91 |
| 801-100C | 10 | 5-3/4 | 5-3/4 | 10-13/16 | 10-13/16 | 21-5/8 | 11-19/32 | 40.50 |
| 801-100CF | 10 | 9 | 9 | 14-1/4 | 14-1/4 | 28-1/2 | 11-15/16 | 51.41 |
| 801-120C | 12 | 6-15/16 | 6-15/16 | 12-15/16 | 12-15/16 | 25-7/8 | 14-1/4 | 62.00 |
| 801-120CF | 12 | 11-1/4 | 11-1/4 | 17-1/2 | 17-1/2 | 35 | 14-1/8 | 83.37 |
| 801-140C | 14 | 7-1/32 | 7-1/32 | 14-7/32 | 14-1/32 | 28-7/16 | 15-21/32 | 70.48 |
| 801-140CF | 14 | 12-1/4 | 12-1/4 | 19-1/4 | 19-1/4 | 38-1/2 | 15-1/2 | 108.34 |
| 801-160CF | 16 | 13 | 13 | 21 | 21 | 42 | 17-11/16 | 144.86 |
| 801-180CF | 18 | 13-3/4 | 13-3/4 | 22-3/4 | 22-3/4 | 45-1/2 | 19-7/8 | 198.00 |
| 801-200CF | 20 | 16-3/8 | 16-3/8 | 26-3/8 | 26-3/8 | 52-3/4 | 22-1/16 | 249.75 |
| 801-240CF | 24 | 20-1/4 | 20-1/4 | 32-1/4 | 32-1/4 | 64-1/2 | 26-7/16 | 460.00 |

REDUCING TEE
 Socket x Socket x Socket

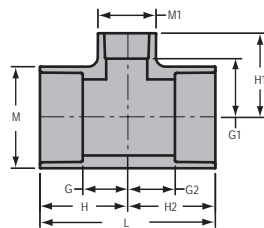

| Part Number | Size | G | G1 | G2 | H | H1 | H2 | L | M | M1 | Approx. Wt. (Lbs.) |
|-----------------------|-----------------|-------|---------|-------|---------|---------|---------|---------|---------|---------|--------------------|
| 801-101C | 3/4x3/4x1/2 | 19/32 | 23/32 | 19/32 | 1-19/32 | 1-19/32 | 1-19/32 | 3-3/16 | 1-13/32 | 1-3/16 | .15 |
| 801-130C | 1x1x1/2 | 19/32 | 7/8 | 19/32 | 1-23/32 | 1-3/4 | 1-23/32 | 3-7/16 | 1-3/4 | 1-3/16 | .21 |
| 801-131C | 1x1x3/4 | 11/16 | 27/32 | 11/16 | 1-27/32 | 1-27/32 | 1-27/32 | 3-21/32 | 1-3/4 | 1-13/32 | .24 |
| 801-158C | 1-1/4x1x1 | 13/32 | 15/16 | 13/32 | 2-1/8 | 1-31/32 | 1-15/16 | 4 | 2-1/16 | 1-11/16 | .34 |
| 801-159C | 1-1/4x1x1-1/4 | 15/16 | 1-1/32 | 7/8 | 2-3/16 | 2-5/32 | 2-1/8 | 4-5/16 | 2-1/16 | 2-1/16 | .41 |
| 801-166C ¹ | 1-1/4x1-1/4x1/2 | 7/8 | 1-13/32 | 7/8 | 2-3/32 | 2-3/8 | 2-3/32 | 4-7/32 | 2-1/8 | 1-3/4 | .43 |
| 801-167C | 1-1/4x1-1/4x3/4 | 5/8 | 31/32 | 5/8 | 1-15/16 | 1-31/32 | 1-15/16 | 3-7/8 | 2-1/8 | 1-13/32 | .30 |
| 801-168C | 1-1/4x1-1/4x1 | 27/32 | 1-1/32 | 27/32 | 2-3/32 | 2-5/32 | 2-3/32 | 4-7/32 | 2-3/32 | 1-3/4 | .36 |

¹ Outlet sized with bushing

Schedule 80 CPVC Technical Information
Schedule 80 CPVC Fittings



Pumping&Plumbing

REDUCING TEE

Socket x Socket x Socket

(continued)

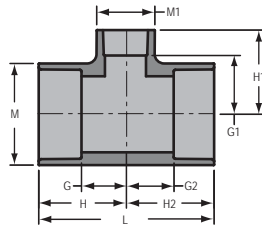

| Part Number | Size | G | G1 | G2 | H | H1 | H2 | L | M | M1 | Approx. Wt. (Lbs.) |
|-----------------------|-------------------|---------|---------|---------|---------|---------|---------|----------|---------|---------|--------------------|
| 801-202C | 1-1/2x1-1/4x1 | 7/8 | 1-7/32 | 7/8 | 2-1/4 | 2-11/32 | 2-1/4 | 4-1/2 | 2-7/16 | 1-13/16 | .42 |
| 801-209C | 1-1/2x1-1/2x1/2 | 9/16 | 1-1/16 | 9/16 | 1-31/32 | 1-15/16 | 1-31/32 | 3-15/16 | 2-3/8 | 1-3/16 | .36 |
| 801-210C | 1-1/2x1-1/2x3/4 | 11/16 | 1-1/32 | 11/16 | 2-1/16 | 2-1/32 | 2-1/16 | 4-5/32 | 2-11/32 | 1-13/32 | .39 |
| 801-211C | 1-1/2x1-1/2x1 | 27/32 | 1-5/32 | 27/32 | 2-15/32 | 2-5/16 | 2-15/32 | 4-15/16 | 2-11/32 | 1-3/4 | .43 |
| 801-212C | 1-1/2x1-1/2x1-1/4 | 1-3/16 | 1-3/16 | 1-3/16 | 2-9/16 | 2-7/16 | 2-9/16 | 5-1/8 | 2-3/8 | 2-1/8 | .57 |
| 801-247C | 2x2x1/2 | 9/16 | 1-13/32 | 9/16 | 2-3/32 | 2-9/32 | 2-3/32 | 4-3/16 | 2-7/8 | 1-5/32 | .46 |
| 801-248C | 2x2x3/4 | 11/16 | 1-7/16 | 11/16 | 2-3/16 | 2-7/16 | 2-3/16 | 4-3/8 | 2-27/32 | 1-13/32 | .52 |
| 801-249C | 2x2x1 | 27/32 | 1-7/16 | 27/32 | 2-3/8 | 2-9/16 | 2-3/8 | 4-3/4 | 2-7/8 | 1-3/4 | .59 |
| 801-250C | 2x2x1-1/4 | 31/32 | 1-11/32 | 31/32 | 2-17/32 | 2-19/32 | 2-17/32 | 5-3/32 | 2-7/8 | 2-1/8 | .64 |
| 801-251C | 2x2x1-1/2 | 1-5/32 | 1-7/16 | 1-5/32 | 2-11/16 | 2-13/32 | 2-11/16 | 5-3/8 | 2-7/8 | 2-13/32 | .80 |
| 801-254C ¹ | 2x2x4 | 3-11/16 | 2-15/32 | 3-11/16 | 5-3/16 | 4-23/32 | 5-3/16 | 10-11/32 | 5-1/4 | 5-1/4 | 5.54 |
| 801-287C | 2-1/2x2-1/2x1/2 | 19/32 | 1-19/32 | 19/32 | 2-3/8 | 2-15/32 | 2-3/8 | 4-23/32 | 3-1/2 | 1-3/16 | .78 |
| 801-288C | 2-1/2x2-1/2x3/4 | 21/32 | 1-1/2 | 21/32 | 2-7/16 | 2-17/32 | 2-7/16 | 4-27/32 | 3-17/32 | 1-13/32 | .83 |
| 801-289C | 2-1/2x2-1/2x1 | 27/32 | 1-23/32 | 27/32 | 2-5/8 | 2-27/32 | 2-5/8 | 5-1/4 | 3-17/32 | 1-23/32 | 1.02 |
| 801-290C | 2-1/2x2-1/2x1-1/4 | 1-1/16 | 1-23/32 | 1-1/16 | 2-27/32 | 2-31/32 | 2-27/32 | 5-11/16 | 3-9/16 | 2-3/32 | 1.16 |
| 801-291C | 2-1/2x2-1/2x1-1/2 | 1-3/16 | 1-3/4 | 1-3/16 | 2-31/32 | 3-1/8 | 2-31/32 | 5-15/16 | 3-7/8 | 2-13/32 | 1.24 |
| 801-292C | 2-1/2x2-1/2x2 | 1-13/32 | 1-5/8 | 1-13/32 | 3-3/16 | 3-1/8 | 3-3/16 | 6-11/32 | 3-1/2 | 2-7/8 | 1.35 |
| 801-333C ¹ | 3x3x1/2 | 1-7/16 | 2-7/8 | 1-7/16 | 3-5/16 | 3-3/4 | 3-5/16 | 6-5/8 | 4-3/16 | 2-7/8 | 2.07 |
| 801-334C ¹ | 3x3x3/4 | 1-7/16 | 2-11/16 | 1-7/16 | 3-5/16 | 3-11/16 | 3-5/16 | 6-5/8 | 4-3/16 | 2-7/8 | 2.05 |
| 801-335C | 3x3x1 | 27/32 | 1-31/32 | 27/32 | 2-3/4 | 3-3/32 | 2-3/4 | 5-15/32 | 4-7/32 | 1-23/32 | 1.29 |
| 801-336C ¹ | 3x3x1-1/4 | 1-5/8 | 1-15/16 | 1-5/8 | 3-5/16 | 3-5/8 | 3-5/16 | 6-5/8 | 4-3/16 | 2-7/8 | 1.97 |
| 801-337C | 3x3x1-1/2 | 1-5/32 | 2-1/16 | 1-5/32 | 3-1/16 | 3-7/16 | 3-1/16 | 6-3/32 | 4-3/16 | 2-3/8 | 1.45 |
| 801-338C | 3x3x2 | 1-7/16 | 1-13/16 | 1-7/16 | 3-5/16 | 3-5/16 | 3-5/16 | 6-5/8 | 4-7/32 | 2-7/8 | 1.69 |
| 801-339C | 3x3x2-1/2 | 1-3/4 | 1-31/32 | 1-3/4 | 3-5/8 | 3-11/16 | 3-5/8 | 7-1/4 | 4-3/16 | 3-17/32 | 2.11 |
| 801-415C ¹ | 4x4x1/2 | 1-7/16 | 3-17/32 | 1-7/16 | 3-11/16 | 4-13/32 | 3-11/16 | 7-11/32 | 5-1/4 | 2-7/8 | 2.72 |
| 801-417C ¹ | 4x4x1 | 1-15/32 | 3-9/32 | 1-15/32 | 3-11/16 | 4-3/8 | 3-11/16 | 7-3/8 | 5-7/32 | 2-7/8 | 2.87 |
| 801-418C ¹ | 4x4x1-1/4 | 1-1/8 | 2-31/32 | 1-1/8 | 3-13/32 | 4-7/32 | 3-13/32 | 6-25/32 | 5-1/4 | 2-3/8 | 2.63 |
| 801-419C | 4x4x1-1/2 | 1-1/8 | 2-9/16 | 1-1/8 | 3-3/8 | 3-15/16 | 3-3/8 | 6-3/4 | 5-1/4 | 2-3/8 | 2.17 |
| 801-420C | 4x4x2 | 1-7/16 | 2-1/2 | 1-7/16 | 3-11/16 | 4 | 3-11/16 | 7-3/8 | 5-1/4 | 2-7/8 | 2.42 |
| 801-421C ¹ | 4x4x2-1/2 | 2-1/16 | 2-11/16 | 2-1/16 | 4-5/16 | 4-3/4 | 4-5/16 | 8-5/8 | 5-1/4 | 4-1/8 | 3.68 |
| 801-422C | 4x4x3 | 2-1/8 | 2-23/32 | 2-1/8 | 4-3/8 | 4-19/32 | 4-3/8 | 8-25/32 | 5-1/4 | 4-3/16 | 3.17 |
| 801-486C ¹ | 5x5x2 | 3-5/32 | 5-3/32 | 3-5/32 | 5-13/16 | 6-19/32 | 5-13/16 | 11-19/32 | 6-13/32 | 6-13/32 | 8.85 |
| 801-486CF | 5x5x2 | 4-5/16 | 4-3/4 | 4-5/16 | 7-5/16 | 6-1/2 | 7-5/16 | 14-5/8 | 6-5/16 | 2-13/16 | 10.83 |
| 801-488C ¹ | 5x5x3 | 3-5/32 | 4-5/8 | 3-5/32 | 5-13/16 | 6-1/2 | 5-13/16 | 11-19/32 | 6-13/32 | 6-13/32 | 8.61 |
| 801-490C ¹ | 5x5x4 | 3-5/32 | 3-29/32 | 3-5/32 | 5-13/16 | 6-5/32 | 5-13/16 | 11-5/8 | 6-13/32 | 6-13/32 | 7.75 |

¹ Outlet sized with bushing





Pumping & Plumbing

Schedule 80 CPVC Technical Information
Schedule 80 CPVC Fittings

REDUCING TEE (continued)

Socket x Socket x Socket

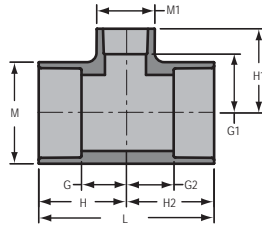

| Part Number | Size | G | G1 | G2 | H | H1 | H2 | L | M | M1 | Approx. Wt. (Lbs.) |
|-----------------------|-------------|---------|----------|---------|----------|----------|----------|----------|----------|----------|--------------------|
| 801-524C ¹ | 6x6x3/4 | 1 | 4 | 1 | 3-7/8 | 5 | 3-7/8 | 7-3/4 | 7-9/16 | 1-3/4 | 4.48 |
| 801-525C | 6x6x1 | 27/32 | 3-23/32 | 27/32 | 3-7/8 | 4-27/32 | 3-7/8 | 7-3/4 | 7-9/16 | 1-3/4 | 4.43 |
| 801-526C ¹ | 6x6x1-1/4 | 1-7/16 | 4-3/16 | 1-7/16 | 4-7/16 | 5-15/32 | 4-7/16 | 8-7/8 | 7-19/32 | 2-7/8 | 5.46 |
| 801-527C | 6x6x1-1/2 | 1-7/16 | 4-3/32 | 1-7/16 | 4-7/16 | 5-1/2 | 4-7/16 | 8-7/8 | 7-19/32 | 2-7/8 | 7.16 |
| 801-528C | 6x6x2 | 1-7/16 | 3-23/32 | 1-7/16 | 4-7/16 | 5-1/4 | 4-7/16 | 8-7/8 | 7-19/32 | 2-7/8 | 5.29 |
| 801-529C ¹ | 6x6x2-1/2 | 2-1/16 | 3-13/16 | 2-1/16 | 5-1/16 | 5-7/8 | 5-1/16 | 10-1/8 | 7-9/16 | 4-1/4 | 8.99 |
| 801-530C | 6x6x3 | 2-1/16 | 3-3/4 | 2-1/16 | 5-3/32 | 5-5/8 | 5-3/32 | 10-3/16 | 7-19/32 | 4-1/4 | --- |
| 801-530CF | 6x6x3 | 4-3/4 | 5-3/4 | 4-3/4 | 8 | 8 | 8 | 16 | 7-1/2 | 4-1/8 | 11.74 |
| 801-532C | 6x6x4 | 2-11/16 | 3-13/16 | 2-11/16 | 5-11/16 | 6-3/32 | 5-11/16 | 11-3/8 | 7-19/32 | 5-1/4 | 8.21 |
| 801-533CF | 6x6x5 | 5-3/4 | 6-1/2 | 5-3/4 | 9 | 9-1/2 | 9 | 18 | 7-1/2 | 6-5/16 | 11.90 |
| 801-575C ¹ | 8x8x1 | 3-25/32 | 7-25/32 | 3-25/32 | 7-25/32 | 8-13/16 | 7-25/32 | 15-9/16 | 9-5/8 | 7-1/2 | 18.76 |
| 801-578C ¹ | 8x8x2 | 3-13/16 | 6-5/8 | 3-13/16 | 7-13/16 | 8-1/8 | 7-13/16 | 15-5/8 | 9-11/16 | 7-9/16 | 18.19 |
| 801-578CF | 8x8x2 | 4-11/16 | 6-1/8 | 4-11/16 | 8-15/16 | 7-7/8 | 8-15/16 | 17-7/8 | 9-5/8 | 2-13/16 | 14.76 |
| 801-579CF | 8x8x2-1/2 | 4-7/8 | 6-15/16 | 4-7/8 | 9-1/8 | 8-5/16 | 9-1/8 | 18-1/4 | 9-5/8 | 3-7/16 | 14.85 |
| 801-580C ¹ | 8x8x3 | 3-23/32 | 6-1/2 | 3-23/32 | 7-3/4 | 8-3/8 | 7-3/4 | 15-1/2 | 9-11/16 | 7-1/2 | 18.44 |
| 801-580CF | 8x8x3 | 5-3/16 | 6-11/16 | 5-3/16 | 9-7/16 | 8-15/16 | 9-7/16 | 18-7/8 | 9-5/8 | 4-1/8 | 20.04 |
| 801-582C | 8x8x4 | 2-5/8 | 4-27/32 | 2-5/8 | 6-5/8 | 7-3/32 | 6-5/8 | 13-1/4 | 9-3/4 | 5-1/4 | 11.60 |
| 801-582CF | 8x8x4 | 2-5/8 | 4-27/32 | 2-5/8 | 6-5/8 | 7-3/32 | 6-5/8 | 13-1/4 | 9-3/4 | 5-1/4 | 11.60 |
| 801-585C | 8x8x6 | 3-7/8 | 4-15/16 | 3-7/8 | 7-29/32 | 7-31/32 | 7-29/32 | 15-25/32 | 9-11/16 | 7-17/32 | 16.17 |
| 801-621CF | 10x10x2 | 4-3/8 | 7-1/8 | 4-3/8 | 9-5/8 | 8-7/8 | 9-5/8 | 19-1/4 | 11-15/16 | 2-13/16 | 27.33 |
| 801-622CF | 10x10x2-1/2 | 5-1/4 | 7-5/16 | 5-1/4 | 10-1/2 | 9-5/16 | 10-1/2 | 21 | 11-15/16 | 3-7/16 | 22.50 |
| 801-623C ¹ | 10x10x3 | 3-25/32 | 7-17/32 | 3-25/32 | 9-3/8 | 9-3/8 | 9-3/8 | 18-25/32 | 12-1/16 | 7-9/16 | 28.69 |
| 801-623CF | 10x10x3 | 4-7/8 | 7-11/16 | 4-7/8 | 10-1/8 | 9-15/16 | 10-1/8 | 20-1/4 | 11-15/16 | 4-1/8 | 24.27 |
| 801-624C | 10x10x4 | 3-7/8 | 7-3/16 | 3-7/8 | 9-3/8 | 9-1/2 | 9-3/8 | 18-3/4 | 12-1/16 | 7-9/16 | 28.54 |
| 801-624CF | 10x10x4 | 5-3/8 | 8-11/16 | 5-3/8 | 10-5/8 | 10-15/16 | 10-5/8 | 21-1/4 | 11-15/16 | 5-3/16 | 26.65 |
| 801-626C | 10x10x6 | 3-7/8 | 5-27/32 | 3-7/8 | 9-3/8 | 8-27/32 | 9-3/8 | 18-3/4 | 12-1/16 | 7-9/16 | 25.50 |
| 801-626CF | 10x10x6 | 5-7/8 | 9-1/16 | 5-7/8 | 11-1/8 | 12-5/16 | 11-1/8 | 22-1/4 | 11-15/16 | 7-1/2 | 29.89 |
| 801-628C ¹ | 10x10x8 | 5-15/16 | 7-3/4 | 5-15/16 | 11-7/16 | 11-3/4 | 11-7/16 | 22-7/8 | 12-1/16 | 12-1/16 | 48.52 |
| 801-628CF | 10x10x8 | 8-1/4 | 9-15/16 | 8-1/4 | 13-1/2 | 14-3/16 | 13-1/2 | 27 | 11-15/16 | 9-5/8 | 38.11 |
| 801-661CF | 12x12x2 | 4-3/4 | 8 | 4-3/4 | 11 | 9-3/4 | 11 | 22 | 14-1/8 | 2-13/16 | 36.76 |
| 801-663CF | 12x12x3 | 5-1/4 | 8-9/16 | 5-1/4 | 11-1/2 | 10-13/16 | 11-1/2 | 23 | 14-1/8 | 4-1/8 | 34.63 |
| 801-664C ¹ | 12x12x4 | 4-11/32 | 10-1/8 | 4-11/32 | 10-15/16 | 12-3/8 | 10-15/16 | 21-7/8 | 14-1/4 | 9-23/32 | 38.17 |
| 801-664CF | 12x12x4 | 5-3/4 | 9-9/16 | 5-3/4 | 12 | 11-13/16 | 12 | 24 | 14-1/8 | 5-3/16 | 38.17 |
| 801-666CF | 12x12x6 | 7-1/4 | 9-15/16 | 7-1/4 | 13-1/4 | 13-3/16 | 13-1/4 | 26-1/2 | 14-1/8 | 7-1/2 | 55.70 |
| 801-668C | 12x12x8 | 4-27/32 | 7-1/2 | 4-27/32 | 11-13/32 | 11-1/8 | 11-13/32 | 22-13/16 | 14-1/4 | 9-23/32 | 42.00 |
| 801-668CF | 12x12x8 | 8 | 10-13/16 | 8 | 14-1/4 | 15-1/16 | 14-1/4 | 28-1/2 | 14-1/8 | 9-5/8 | 66.12 |
| 801-670CF | 12x12x10 | 10-1/4 | 10-13/16 | 10-1/4 | 16-1/2 | 16-1/16 | 16-1/2 | 33 | 14-1/8 | 11-15/16 | 70.97 |
| 801-691CF | 14x14x2 | 5-3/16 | 8-9/16 | 5-3/16 | 12-3/16 | 10-5/16 | 12-3/16 | 24-3/8 | 15-1/2 | 2-13/16 | 44.73 |
| 801-692CF | 14x14x2-1/2 | 5-7/16 | 8-3/4 | 5-7/16 | 12-7/16 | 10-3/4 | 12-7/16 | 24-7/8 | 15-1/2 | 3-7/16 | 45.01 |
| 801-693CF | 14x14x3 | 5-3/4 | 9-1/8 | 5-3/4 | 12-3/4 | 11-3/8 | 12-3/4 | 25-1/2 | 15-1/2 | 4-1/8 | 56.80 |

¹ Outlet sized with bushing

Schedule 80 CPVC Technical Information
Schedule 80 CPVC Fittings



Pumping&Plumbing

REDUCING TEE (continued)
 Socket x Socket x Socket

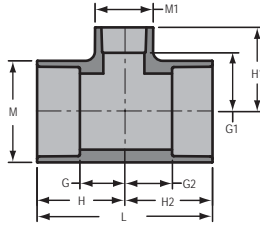

| Part Number | Size | G | G1 | G2 | H | H1 | H2 | L | M | M1 | Approx. Wt. (Lbs.) |
|-------------|-------------|---------|----------|---------|----------|----------|----------|---------|----------|----------|--------------------|
| 801-694CF | 14x14x4 | 6-1/2 | 10-1/8 | 6-1/2 | 13-1/2 | 12-3/8 | 13-1/2 | 27 | 15-1/2 | 5-3/16 | 50.00 |
| 801-696CF | 14x14x6 | 8-1/4 | 10-1/2 | 8-1/4 | 15-1/4 | 13-3/4 | 15-1/4 | 30-1/2 | 15-1/2 | 7-1/2 | 63.15 |
| 801-698CF | 14x14x8 | 9-1/4 | 11-3/8 | 9-1/4 | 16-1/4 | 15-5/8 | 16-1/4 | 32-1/2 | 15-1/2 | 9-5/8 | 68.17 |
| 801-700CF | 14x14x10 | 10-1/8 | 11-3/8 | 10-1/8 | 17-1/8 | 16-5/8 | 17-1/8 | 34-1/4 | 15-1/2 | 11-15/16 | 89.80 |
| 801-702C | 14x14x12 | 7-1/32 | 7-13/32 | 7-1/32 | 14-1/32 | 13-13/32 | 14-1/32 | 28-1/16 | 15-21/32 | 14-11/32 | 65.49 |
| 801-702CF | 14x14x12 | 11 | 11-3/8 | 11 | 18 | 17-5/8 | 18 | 36 | 15-1/2 | 14-1/8 | 93.81 |
| 801-751CF | 16x16x2 | 5-7/8 | 9-1/2 | 5-7/8 | 13-7/8 | 11-1/4 | 13-7/8 | 27-3/4 | 17-11/16 | 2-13/16 | 71.71 |
| 801-752CF | 16x16x2-1/2 | 6 | 9-11/16 | 6 | 14 | 11-11/16 | 14 | 28 | 17-11/16 | 3-7/16 | 64.80 |
| 801-753CF | 16x16x3 | 6-5/16 | 10-1/16 | 6-5/16 | 14-5/16 | 12-5/16 | 14-5/16 | 28-5/8 | 17-11/16 | 4-1/8 | 67.39 |
| 801-754CF | 16x16x4 | 6-1/8 | 11-1/16 | 6-1/8 | 14-1/8 | 13-5/16 | 14-1/8 | 28-1/4 | 17-11/16 | 5-3/16 | 70.21 |
| 801-756CF | 16x16x6 | 8-5/8 | 11-7/16 | 8-5/8 | 16-5/8 | 14-11/16 | 16-5/8 | 33-1/4 | 17-11/16 | 7-1/2 | 90.09 |
| 801-758CF | 16x16x8 | 9-5/8 | 12-5/16 | 9-5/8 | 17-5/8 | 16-9/16 | 17-5/8 | 35-1/4 | 17-11/16 | 9-5/8 | 98.00 |
| 801-760CF | 16x16x10 | 10-5/8 | 12-5/16 | 10-5/8 | 18-5/8 | 17-9/16 | 18-5/8 | 37-1/4 | 17-11/16 | 11-15/16 | 119.71 |
| 801-762CF | 16x16x12 | 11-5/8 | 12-5/16 | 11-5/8 | 19-5/8 | 18-9/16 | 19-5/8 | 39-1/4 | 17-11/16 | 14-1/8 | 116.70 |
| 801-764CF | 16x16x14 | 12-3/4 | 12-11/16 | 12-3/4 | 20-3/4 | 19-11/16 | 20-3/4 | 41-1/2 | 17-11/16 | 15-1/2 | 129.51 |
| 801-784CF | 18x18x4 | 6-7/8 | 11-15/16 | 6-7/8 | 15-7/8 | 14-3/16 | 15-7/8 | 31-3/4 | 19-7/8 | 5-3/16 | 99.22 |
| 801-786CF | 18x18x6 | 8-1/2 | 12-5/16 | 8-1/2 | 17-1/2 | 15-9/16 | 17-1/2 | 35 | 19-7/8 | 7-1/2 | 117.69 |
| 801-788CF | 18x18x8 | 9-1/2 | 13-3/16 | 9-1/2 | 18-1/2 | 17-7/16 | 18-1/2 | 37 | 19-7/8 | 9-5/8 | 127.49 |
| 801-790CF | 18x18x10 | 10-1/2 | 13-3/16 | 10-1/2 | 19-1/2 | 18-7/16 | 19-1/2 | 39 | 19-7/8 | 11-15/16 | 138.59 |
| 801-792CF | 18x18x12 | 11-1/2 | 13-3/16 | 11-1/2 | 20-1/2 | 19-7/16 | 20-1/2 | 41 | 19-7/8 | 14-1/8 | 150.34 |
| 801-794CF | 18x18x14 | 12-3/4 | 13-9/16 | 12-3/4 | 21-3/4 | 20-9/16 | 21-3/4 | 43-1/2 | 19-11/16 | 15-1/2 | 165.78 |
| 801-796CF | 18x18x16 | 13-1/2 | 14-3/16 | 13-1/2 | 22-1/2 | 22-3/16 | 22-1/2 | 45 | 19-11/16 | 17-11/16 | 172.46 |
| 801-814CF | 20x20x4 | 7-11/16 | 12-7/8 | 7-11/16 | 17-11/16 | 15-1/8 | 17-11/16 | 35-3/8 | 22-1/16 | 5-3/16 | 116.55 |
| 801-816CF | 20x20x6 | 8-7/8 | 13-1/4 | 8-7/8 | 18-7/8 | 16-1/2 | 18-7/8 | 37-3/4 | 22-1/16 | 7-1/2 | 147.44 |
| 801-818CF | 20x20x8 | 9-7/8 | 14-1/8 | 9-7/8 | 19-7/8 | 18-3/8 | 19-7/8 | 39-3/4 | 22-1/16 | 9-5/8 | 151.48 |
| 801-820CF | 20x20x10 | 10-7/8 | 14-1/8 | 10-7/8 | 20-7/8 | 19-3/8 | 20-7/8 | 41-3/4 | 22-1/16 | 11-15/16 | 163.28 |
| 801-822CF | 20x20x12 | 11-7/8 | 14-1/8 | 11-7/8 | 21-7/8 | 20-3/8 | 21-7/8 | 43-3/4 | 22-1/16 | 14-1/8 | 176.50 |
| 801-824CF | 20x20x14 | 12-7/8 | 14-1/2 | 12-7/8 | 22-7/8 | 21-1/2 | 22-7/8 | 45-3/4 | 22-1/16 | 15-1/2 | 190.95 |
| 801-826CF | 20x20x16 | 14 | 15-1/8 | 14 | 24 | 23-1/8 | 24 | 48 | 22-1/16 | 17-11/16 | 210.27 |
| 801-828CF | 20x20x18 | 15 | 15 | 15 | 25 | 24 | 25 | 50 | 22-1/16 | 19-7/8 | 226.80 |
| 801-904CF | 24x24x4 | 9 | 14-11/16 | 9 | 21 | 16-15/16 | 21 | 42 | 26-7/16 | 5-3/16 | 195.97 |
| 801-906CF | 24x24x6 | 9-1/4 | 15-1/16 | 9-1/4 | 21-1/4 | 18-5/16 | 21-1/4 | 42-1/2 | 26-7/16 | 7-1/2 | 202.94 |
| 801-908CF | 24x24x8 | 10-1/4 | 15-15/16 | 10-1/4 | 22-1/4 | 20-3/16 | 22-1/4 | 44-1/2 | 26-7/16 | 9-5/8 | 236.29 |
| 801-910CF | 24x24x10 | 11-1/4 | 15-15/16 | 11-1/4 | 23-1/4 | 21-3/16 | 23-1/4 | 46-1/2 | 26-7/16 | 11-15/16 | 255.95 |
| 801-912CF | 24x24x12 | 12-1/4 | 15-15/16 | 12-1/4 | 24-1/4 | 22-3/16 | 24-1/4 | 48-1/2 | 26-7/16 | 14-1/8 | 295.00 |
| 801-914CF | 24x24x14 | 13-1/4 | 16-5/16 | 13-1/4 | 25-1/4 | 23-5/16 | 25-1/4 | 50-1/2 | 26-7/16 | 15-1/2 | 282.42 |
| 801-916CF | 24x24x16 | 14-3/4 | 16-15/16 | 14-3/4 | 26-3/4 | 24-15/16 | 26-3/4 | 53-1/2 | 26-7/16 | 17-11/16 | 306.44 |
| 801-918CF | 24x24x18 | 15-3/4 | 16-13/16 | 15-3/4 | 27-3/4 | 25-13/16 | 27-3/4 | 55-1/2 | 26-7/16 | 19-7/8 | 246.78 |
| 801-920CF | 24x24x20 | 16-3/4 | 18-3/16 | 16-3/4 | 28-3/4 | 28-3/16 | 28-3/4 | 57-1/2 | 26-7/16 | 22-1/16 | 351.60 |





Pumping&Plumbing

Schedule 80 CPVC Technical Information
Schedule 80 CPVC Fittings

TEE

Socket x Socket x Fipt

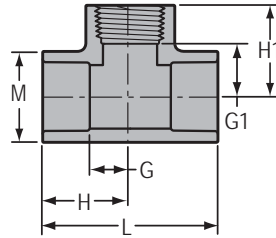

| Part Number | Size | G | G1 | H | H1 | L | M | Approx. Wt. (Lbs.) |
|-------------|-------|---------|----------|---------|---------|----------|---------|--------------------|
| 802-002C | 1/4 | 5/16 | 3/8 | 15/16 | 15/16 | 1-29/32 | 7/8 | .05 |
| 802-005C | 1/2 | 19/32 | 21/32 | 1-15/32 | 1-11/32 | 2-15/16 | 1-3/16 | .12 |
| 802-007C | 3/4 | 5/8 | 5/8 | 1-19/32 | 1-13/32 | 3-3/16 | 1-13/32 | .15 |
| 802-010C | 1 | 11/16 | 3/4 | 1-13/16 | 1-5/8 | 3-13/16 | 1-13/16 | .24 |
| 802-012C | 1-1/4 | 13/16 | 1-1/16 | 2-3/32 | 1-15/16 | 4-5/32 | 2-3/32 | .37 |
| 802-015C | 1-1/2 | 29/32 | 1-1/4 | 2-11/32 | 2-5/32 | 4-11/16 | 2-3/8 | .51 |
| 802-020C | 2 | 1-9/32 | 1-15/32 | 2-13/16 | 2-13/32 | 5-21/32 | 2-7/8 | .80 |
| 802-030C | 3 | 1-31/32 | 2-1/8 | 3-3/4 | 3-17/32 | 7-15/32 | 4-5/16 | 2.38 |
| 802-040C | 4 | 2-11/32 | 2-21/32 | 4-5/8 | 4-5/32 | 9-7/32 | 5-9/32 | 3.44 |
| 802-060CF | 6 | 4 | 8-9/16 | 7-1/16 | 10 | 14-1/8 | 7-9/16 | 15.09 |
| 802-080CF | 8 | 4-13/16 | 10-13/16 | 8-13/16 | 12-9/16 | 17-11/16 | 9-11/16 | 27.08 |

REDUCING TEE

Socket x Socket x Fipt

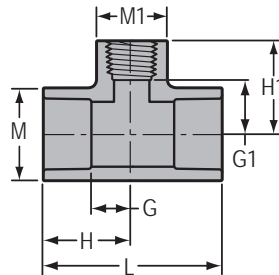

| Part Number | Size | G | G1 | H | H1 | L | M | M1 | Approx. Wt. (Lbs.) |
|-----------------------|-----------------|-------|---------|---------|---------|--------|---------|---------|--------------------|
| 802-101C | 3/4x3/4x1/2 | 19/32 | 25/32 | 1-19/32 | 1-7/16 | 3-7/32 | 1-13/32 | 1-3/16 | .15 |
| 802-130C | 1x1x1/2 | 7/16 | 29/32 | 1-9/16 | 1-5/8 | 3-1/8 | 1-23/32 | 1-7/16 | .19 |
| 802-131C | 1x1x3/4 | 21/32 | 13/16 | 1-13/16 | 1-17/32 | 3-5/8 | 1-23/32 | 1-3/8 | .22 |
| 802-166C | 1-1/4x1-1/4x1/2 | 7/16 | 1-1/8 | 1-11/16 | 1-27/32 | 3-3/8 | 2-3/32 | 1-3/16 | .26 |
| 802-167C ¹ | 1-1/4x1-1/4x3/4 | 7/8 | 1-23/32 | 2-1/8 | 2-7/16 | 4-7/32 | 2-3/32 | 1-3/4 | .42 |
| 802-168C | 1-1/4x1-1/4x1 | 27/32 | 1-1/32 | 2-3/32 | 1-29/32 | 4-7/32 | 2-3/32 | 1-11/16 | .35 |
| 802-209C ¹ | 1-1/2x1-1/2x1/2 | 11/16 | 1-9/16 | 2-3/32 | 2-9/32 | 4-5/32 | 2-11/32 | 1-13/32 | .42 |
| 802-210C ¹ | 1-1/2x1-1/2x3/4 | 7/8 | 1-27/32 | 2-1/4 | 2-19/32 | 4-1/2 | 2-3/8 | 1-11/16 | .54 |

¹ Outlet sized with bushing

Schedule 80 CPVC Technical Information
Schedule 80 CPVC Fittings



Pumping&Plumbing

REDUCING TEE (continued)

Socket x Socket x Fipt

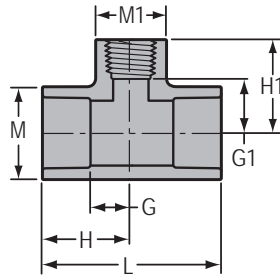

| Part Number | Size | G | G1 | H | H1 | L | M | M1 | Approx. Wt. (Lbs.) |
|-----------------------|-------------------|---------|---------|---------|---------|---------|---------|---------|--------------------|
| 802-211C | 1-1/2x1-1/2x1 | 27/32 | 1-9/32 | 2-1/4 | 2-3/32 | 4-15/32 | 2-3/8 | 1-11/16 | .43 |
| 802-212C | 1-1/2x1-1/2x1-1/4 | 1-1/32 | 1-5/32 | 2-7/16 | 2-3/32 | 4-27/32 | 2-3/8 | 2-1/16 | .49 |
| 802-247C ¹ | 2x2x1/2 | 1/2 | 1-1/2 | 2 | 2-7/32 | 4 | 2-7/8 | 1-3/16 | .46 |
| 802-248C | 2x2x3/4 | 5/8 | 1-3/8 | 2-1/8 | 2-3/32 | 4-1/4 | 2-7/8 | 1-3/8 | .49 |
| 802-249C | 2x2x1 | 27/32 | 1-1/2 | 2-11/32 | 2-11/32 | 4-11/16 | 2-7/8 | 1-11/16 | .57 |
| 802-250C ¹ | 2x2x1-1/4 | 1-3/16 | 2-1/16 | 2-11/16 | 3 | 5-3/8 | 2-7/8 | 2-13/32 | .90 |
| 802-251C ¹ | 2x2x1-1/2 | 1-7/16 | 2-5/16 | 2-15/16 | 3-11/32 | 5-7/8 | 2-7/8 | 2-7/8 | 1.21 |
| 802-287C | 2-1/2x2-1/2x1/2 | 9/16 | 1-25/32 | 2-5/16 | 2-15/32 | 4-19/32 | 3-1/2 | 1-3/16 | .81 |
| 802-288C ¹ | 2-1/2x2-1/2x3/4 | 27/32 | 2-11/32 | 2-21/32 | 3-5/32 | 5-9/32 | 3-9/16 | 1-13/16 | 1.12 |
| 802-289C ¹ | 2-1/2x2-1/2x1 | 1-3/32 | 2-11/32 | 2-27/32 | 3-1/4 | 5-11/16 | 3-1/2 | 2-1/8 | 1.21 |
| 802-290C ¹ | 2-1/2x2-1/2x1-1/4 | 1-3/16 | 2-15/32 | 2-31/32 | 3-15/32 | 5-15/16 | 3-1/2 | 2-3/8 | 1.34 |
| 802-291C ¹ | 2-1/2x2-1/2x1-1/2 | 1-7/16 | 2-1/2 | 3-3/16 | 3-1/2 | 6-3/8 | 3-1/2 | 2-7/8 | 1.55 |
| 802-292C ¹ | 2-1/2x2-1/2x2 | 1-3/4 | 3-15/16 | 3-1/2 | 2-7/8 | 7 | 3-15/32 | 3-15/32 | 2.15 |
| 802-333C ¹ | 3x3x1/2 | 7/8 | 2-11/16 | 2-3/4 | 3-7/16 | 5-1/2 | 4-1/8 | 1-23/32 | 1.30 |
| 802-334C ¹ | 3x3x3/4 | 7/8 | 2-19/32 | 2-3/4 | 3-11/32 | 5-1/2 | 4-3/16 | 1-3/4 | 1.33 |
| 802-335C ¹ | 3x3x1 | 1-3/16 | 2-31/32 | 3-1/16 | 3-7/8 | 6-1/8 | 4-1/8 | 2-11/32 | 1.61 |
| 802-337C ¹ | 3x3x1-1/2 | 1-7/16 | 2-23/32 | 3-5/16 | 3-23/32 | 6-5/8 | 4-1/4 | 2-29/32 | 1.98 |
| 802-338C ¹ | 3x3x2 | 2-3/32 | 3-11/32 | 3-31/32 | 4-3/8 | 7-15/16 | 4-5/32 | 4-5/32 | 3.51 |
| 802-339C ¹ | 3x3x2-1/2 | 2-3/32 | 2-3/4 | 3-31/32 | 4-5/16 | 7-15/16 | 4-1/8 | 4-1/8 | 3.34 |
| 802-415C ¹ | 4x4x1/2 | 1-7/16 | 3-5/8 | 3-11/16 | 4-3/8 | 7-3/8 | 5-1/4 | 2-7/8 | 2.71 |
| 802-416C ¹ | 4x4x3/4 | 1-15/32 | 3-27/32 | 3-23/32 | 4-17/32 | 7-7/16 | 5-1/4 | 2-7/8 | 2.86 |
| 802-417C ¹ | 4x4x1 | 1-7/16 | 3-17/32 | 3-23/32 | 4-13/32 | 7-13/32 | 5-1/4 | 2-7/8 | 2.87 |
| 802-419C ¹ | 4x4x1-1/2 | 3-11/16 | 3-1/2 | 3-11/16 | 3-31/32 | 7-3/8 | 5-1/4 | 2-7/8 | 2.80 |
| 802-420C ¹ | 4x4x2 | 2-1/8 | 4-1/32 | 4-3/8 | 5-1/32 | 8-25/32 | 5-1/4 | 4-3/16 | 3.84 |
| 802-421C ¹ | 4x4x2-1/2 | 2-1/8 | 3-15/32 | 4-3/8 | 5 | 8-25/32 | 5-1/4 | 4-3/16 | 3.71 |
| 802-422C ¹ | 4x4x3 | 2-5/8 | 3-5/8 | 4-7/8 | 5-1/4 | 9-3/4 | 5-1/4 | 5-1/4 | 5.30 |
| 802-525C ¹ | 6x6x1 | 2-1/16 | 5-3/16 | 5-3/32 | 6-1/16 | 10-5/32 | 7-19/32 | 4-1/4 | 9.23 |
| 802-529C ¹ | 6x6x2-1/2 | 2-1/16 | 4-21/32 | 5-3/32 | 6-3/16 | 10-5/32 | 7-19/32 | 4-1/4 | 9.12 |
| 802-530C ¹ | 6x6x3 | 2-11/16 | 4-3/4 | 5-9/16 | 6-3/8 | 11-1/8 | 7-1/2 | 5-1/4 | 8.33 |

¹ Outlet sized with bushing





Pumping&Plumbing

Schedule 80 CPVC Technical Information
Schedule 80 CPVC Fittings

REDUCING TEE

Socket x Fipt x Socket

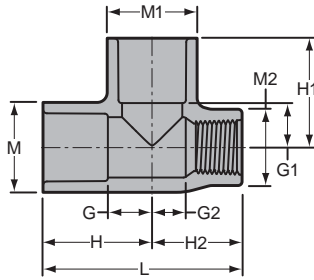

| Part Number | Size | G | G1 | G2 | H | H1 | H2 | L | M | M1 | M2 | Approx. Wt. (Lbs.) |
|-------------|-------------|-------|-------|-------|---------|---------|-------|--------|---------|---------|--------|--------------------|
| 803-095C | 3/4x1/2x3/4 | 11/16 | 11/16 | 11/16 | 1-11/16 | 1-11/16 | 1-3/8 | 3-3/32 | 1-13/32 | 1-13/32 | 1-3/16 | .15 |

SPECIAL REINFORCED REDUCING TEE

Socket x SR Fipt x Socket

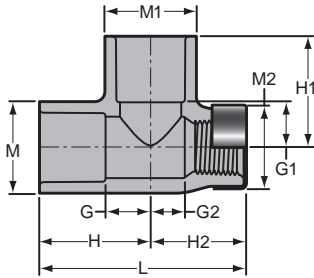

| Part Number | Size | G | G1 | G2 | H | H1 | H2 | L | M | M1 | M2 | Approx. Wt. (Lbs.) |
|-------------|-------------|-------|-------|-------|---------|---------|---------|-------|---------|---------|--------|--------------------|
| 803-095CSR | 3/4x1/2x3/4 | 11/16 | 11/16 | 11/16 | 1-11/16 | 1-11/16 | 1-13/32 | 3-1/8 | 1-13/32 | 1-13/32 | 1-7/32 | .16 |

TEE

Socket x Socket x Brass Fipt

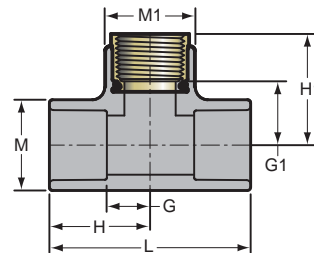

| Part Number | Size | G | G1 | H | H1 | L | M | M1 | Approx. Wt. (Lbs.) |
|-------------|------|-------|--------|---------|---------|--------|---------|--------|--------------------|
| 802-005CBR | 1/2 | 7/8 | 31/32 | 1-7/16 | 1-17/32 | 2-5/8 | 1-5/32 | 1-7/32 | .16 |
| 802-007CBR | 3/4 | 17/32 | 1-3/32 | 1-13/32 | 1-13/16 | 3-1/32 | 1-13/32 | 1-3/8 | .38 |

Not intended to convey or dispense water for human consumption through drinking or cooking

Schedule 80 CPVC Technical Information
Schedule 80 CPVC Fittings



Pumping&Plumbing

REDUCING TEE

Socket x Socket x Brass Fipt

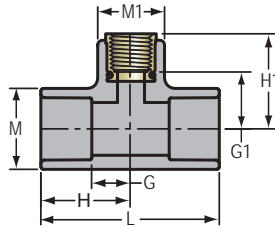

| Part Number | Size | G | G1 | H | H1 | L | M | M1 | Approx. Wt. (Lbs.) |
|-------------|-------------|------|--------|--------|-------|---------|---------|--------|--------------------|
| 802-101CBR | 3/4x3/4x1/2 | 7/16 | 1-1/32 | 1-7/16 | 1-5/8 | 2-29/32 | 1-13/32 | 1-3/16 | .20 |

Not intended to convey or dispense water for human consumption through drinking or cooking

SPECIAL REINFORCED TEE

Socket x Socket x SR Fipt

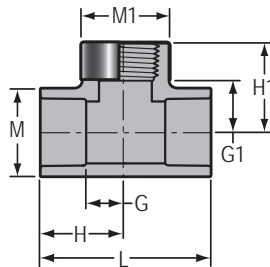

| Part Number | Size | G | G1 | H | H1 | L | M | M1 | Approx. Wt. (Lbs.) |
|-------------|-------|---------|---------|---------|---------|---------|---------|---------|--------------------|
| 802-005CSR | 1/2 | 5/8 | 5/8 | 1-15/32 | 1-3/8 | 2-15/16 | 1-7/32 | 1-13/32 | .15 |
| 802-007CSR | 3/4 | 19/32 | 11/16 | 1-19/32 | 1-13/32 | 3-3/16 | 1-13/32 | 1-13/32 | .15 |
| 802-010CSR | 1 | 21/32 | 11/16 | 1-13/16 | 1-5/8 | 3-5/8 | 1-23/32 | 1-11/16 | .28 |
| 802-012CSR | 1-1/4 | 13/16 | 1-1/16 | 2-3/32 | 1-15/16 | 4-3/16 | 2-3/32 | 2-1/16 | .38 |
| 802-015CSR | 1-1/2 | 15/16 | 1-7/32 | 2-11/32 | 2-5/32 | 4-11/16 | 2-11/32 | 2-7/16 | .53 |
| 802-020CSR | 2 | 1-5/16 | 1-1/2 | 2-13/16 | 2-13/32 | 5-21/32 | 2-7/8 | 3-1/32 | .83 |
| 802-030CSR | 3 | 1-27/32 | 2-3/32 | 3-23/32 | 3-17/32 | 7-7/16 | 4-9/32 | 4-9/32 | 2.44 |
| 802-040CSR | 4 | 2-11/32 | 2-21/32 | 4-5/8 | 4-5/32 | 9-7/32 | 5-1/4 | 5-1/4 | 3.52 |





Pumping&Plumbing

Schedule 80 CPVC Technical Information
Schedule 80 CPVC Fittings

SPECIAL REINFORCED REDUCING TEE

Socket x Socket x SR Fipt

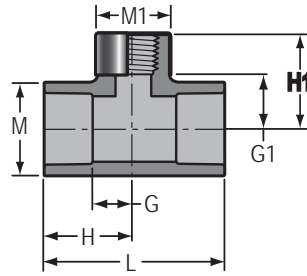

| Part Number | Size | G | G1 | H | H1 | L | M | M1 | Approx. Wt. (Lbs.) |
|-------------------------|-------------------|---------|---------|---------|---------|---------|---------|---------|--------------------|
| 802-072CSR | 1/2x1/2x1/4 | 7/16 | 11/16 | 1-5/16 | 1-7/32 | 2-5/8 | 1-5/32 | 27/32 | .09 |
| 802-098CSR | 3/4x3/4x1/4 | 7/8 | 13/16 | 1-7/16 | 1-5/16 | 2-7/8 | 1-3/8 | 27/32 | .12 |
| 802-101CSR | 3/4x3/4x1/2 | 19/32 | 25/32 | 1-19/32 | 1-7/16 | 3-7/32 | 1-13/32 | 1-3/16 | .15 |
| 802-128CSR ¹ | 1x1x1/4 | 7/8 | 2-5/8 | 2 | 2-11/16 | 4 | 2-3/32 | 27/32 | .38 |
| 802-130CSR | 1x1x1/2 | 7/16 | 29/32 | 1-9/16 | 1-5/8 | 3-1/8 | 1-23/32 | 1-3/16 | .20 |
| 802-131CSR | 1x1x3/4 | 21/32 | 7/8 | 1-13/16 | 1-19/32 | 3-19/32 | 1-23/32 | 1-3/8 | .23 |
| 802-164CSR ¹ | 1-1/4x1-1/4x1/4 | 27/32 | 2-13/16 | 2-1/8 | 3-13/32 | 4-7/32 | 2-3/32 | 27/32 | .45 |
| 802-166CSR | 1-1/4x1-1/4x1/2 | 7/16 | 1-1/8 | 1-11/16 | 1-27/32 | 3-13/32 | 2-3/32 | 1-3/16 | .27 |
| 802-168CSR | 1-1/4x1-1/4x1 | 27/32 | 1-1/32 | 2-3/32 | 1-29/32 | 4-7/32 | 2-3/32 | 1-11/16 | .36 |
| 802-207CSR ¹ | 1-1/2x1-1/2x1/4 | 27/32 | 1-31/32 | 2-1/4 | 2-19/32 | 4-15/32 | 2-11/32 | 1-3/4 | .57 |
| 802-211CSR | 1-1/2x1-1/2x1 | 27/32 | 1-7/32 | 2-1/4 | 2-1/8 | 4-15/32 | 2-3/8 | 1-11/16 | .44 |
| 802-212CSR | 1-1/2x1-1/2x1-1/4 | 1-1/32 | 1-5/32 | 2-7/16 | 2-3/32 | 4-27/32 | 2-3/8 | 2-1/16 | .51 |
| 802-247CSR | 2x2x1/2 | 1/2 | 1-1/2 | 2 | 2-1/4 | 4 | 2-7/8 | 1-3/16 | .48 |
| 802-248CSR | 2x2x3/4 | 19/32 | 1-13/32 | 2-1/8 | 2-1/8 | 4-1/4 | 2-7/8 | 1-3/8 | .50 |
| 802-287CSR | 2-1/2x2-1/2x1/2 | 9/16 | 1-3/4 | 2-5/16 | 2-1/2 | 4-19/32 | 3-1/2 | 1-7/32 | .79 |
| 802-331CSR ¹ | 3x3x1/4 | 1-13/32 | 4-1/2 | 3-5/16 | 5-1/32 | 6-9/16 | 4-3/16 | 27/32 | 3.62 |
| 802-413CSR ¹ | 4x4x1/4 | 1-7/16 | 5-3/16 | 3-11/16 | 5-25/32 | 7-3/8 | 5-1/4 | 27/32 | 2.75 |

¹Outlet sized with bushing

TEE

Fipt x Fipt x Fipt

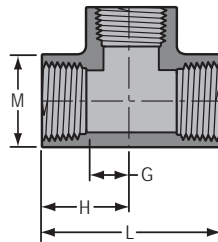

| Part Number | Size | G | H | L | M | Approx. Wt. (Lbs.) |
|-------------|-------|---------|---------|---------|---------|--------------------|
| 805-002C | 1/4 | 1/2 | 1-3/32 | 2-3/16 | 27/32 | .06 |
| 805-003C | 3/8 | 9/16 | 1-5/32 | 2-5/16 | 15/16 | .07 |
| 805-005C | 1/2 | 17/32 | 1-1/4 | 2-15/32 | 1-3/16 | .12 |
| 805-007C | 3/4 | 21/32 | 1-15/32 | 2-15/16 | 1-1/2 | .20 |
| 805-010C | 1 | 23/32 | 1-3/4 | 3-1/2 | 1-11/16 | .29 |
| 805-012C | 1-1/4 | 15/16 | 1-31/32 | 3-29/32 | 2-1/4 | .50 |
| 805-015C | 1-1/2 | 1-1/8 | 2-3/16 | 4-3/8 | 2-13/32 | .62 |
| 805-020C | 2 | 1-5/8 | 2-5/8 | 5-1/4 | 3 | 1.15 |
| 805-025C | 2-1/2 | 1-9/16 | 3-1/8 | 6-1/4 | 3-19/32 | 1.76 |
| 805-030C | 3 | 1-15/16 | 3-9/16 | 7-3/32 | 4-11/32 | 3.01 |
| 805-040C | 4 | 2-15/32 | 4-7/32 | 8-7/16 | 5-3/8 | 4.33 |
| 805-060CF | 6 | 8-1/4 | 9-3/4 | 19-1/2 | 7-3/16 | 24.79 |

Schedule 80 CPVC Technical Information
Schedule 80 CPVC Fittings



Pumping&Plumbing

SPECIAL REINFORCED TEE

SR Fipt x SR Fipt x SR Fipt

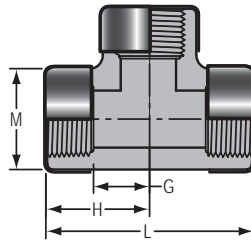

| Part Number | Size | G | H | L | M | Approx. Wt. (Lbs.) |
|-------------|-------|-------|---------|---------|---------|--------------------|
| 805-002CSR | 1/4 | 1/2 | 1-3/32 | 2-3/16 | 27/32 | .07 |
| 805-003CSR | 3/8 | 19/32 | 1-3/16 | 2-11/32 | 31/32 | .09 |
| 805-005CSR | 1/2 | 1/2 | 1-1/4 | 2-1/2 | 1-3/16 | .14 |
| 805-007CSR | 3/4 | 19/32 | 1-11/32 | 2-11/16 | 1-3/8 | .17 |
| 805-010CSR | 1 | 7/8 | 1-25/32 | 3-9/16 | 1-11/16 | .33 |
| 805-015CSR | 1-1/2 | 1-1/4 | 2-3/16 | 4-13/32 | 2-13/32 | .70 |
| 805-020CSR | 2 | 1-5/8 | 2-5/8 | 5-1/4 | 3 | 1.27 |



STREET TEE

Spigot x Socket x Socket

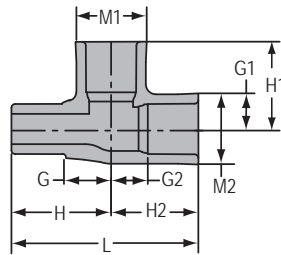

| Part Number | Size | G | G1 | G2 | H | H1 | H2 | L | M1 | M2 | Approx. Wt. (Lbs.) |
|-------------|-------|---------|--------|---------|---------|---------|---------|---------|---------|---------|--------------------|
| 844-005C | 1/2 | 23/32 | 23/32 | 1/2 | 1-19/32 | 1-21/32 | 1-19/32 | 3-5/32 | 1-3/16 | 1-3/16 | .11 |
| 844-007C | 3/4 | 13/16 | 27/32 | 7/8 | 1-13/16 | 1-7/8 | 1-13/16 | 3-5/8 | 1-13/32 | 1-13/32 | .16 |
| 844-010C | 1 | 1-3/32 | 13/16 | 13/16 | 2-7/32 | 2 | 2 | 4-7/32 | 1-3/4 | 1-3/4 | .27 |
| 844-012C | 1-1/4 | 1-1/4 | 1-5/32 | 1-1/8 | 2-7/16 | 2-5/16 | 2-7/16 | 4-7/8 | 2-3/32 | 2-3/32 | .41 |
| 844-015C | 1-1/2 | 1-13/16 | 1-1/8 | 1-1/8 | 2-7/8 | 2-9/16 | 2-9/16 | 5-11/32 | 2-11/32 | 2-11/32 | .54 |
| 844-020C | 2 | 1-23/32 | 1-7/16 | 1-13/32 | 3-1/4 | 2-15/16 | 2-15/16 | 6-5/32 | 2-7/8 | 2-7/8 | .84 |



Pumping&Plumbing

Schedule 80 CPVC Technical Information
Schedule 80 CPVC Fittings

90° ELBOW

Socket x Socket

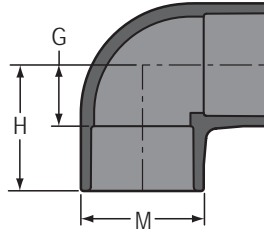

| Part Number | Size | G | H | M | Approx. Wt. (Lbs.) |
|-------------|-------|----------|----------|----------|--------------------|
| 806-002C | 1/4 | 11/32 | 1 | 13/16 | .03 |
| 806-003C | 3/8 | 15/32 | 1-1/4 | 31/32 | .05 |
| 806-005C | 1/2 | 9/16 | 1-15/32 | 1-3/16 | .09 |
| 806-007C | 3/4 | 5/8 | 1-11/16 | 1-7/16 | .12 |
| 806-010C | 1 | 7/8 | 2 | 1-3/4 | .21 |
| 806-012C | 1-1/4 | 1-1/32 | 2-9/32 | 2-3/32 | .31 |
| 806-015C | 1-1/2 | 1-3/32 | 2-9/16 | 2-3/8 | .39 |
| 806-020C | 2 | 1-13/32 | 2-15/16 | 2-7/8 | .62 |
| 806-025C | 2-1/2 | 1-9/16 | 3-11/32 | 3-15/32 | 1.15 |
| 806-030C | 3 | 2-1/16 | 3-31/32 | 4-3/16 | 1.70 |
| 806-040C | 4 | 2-5/8 | 4-7/8 | 5-7/32 | 2.93 |
| 806-050C | 5 | 3 | 5-3/4 | 6-3/8 | 4.69 |
| 806-050CF | 5 | 6-9/16 | 9-9/16 | 6-5/16 | 7.40 |
| 806-060C | 6 | 3-3/4 | 6-3/4 | 7-19/32 | 7.43 |
| 806-080C | 8 | 4-25/32 | 8-25/32 | 9-3/4 | 15.83 |
| 806-080CF | 8 | 9-1/4 | 13-1/2 | 9-5/8 | 22.53 |
| 806-100C | 10 | 5-25/32 | 11-11/32 | 12-1/16 | 28.74 |
| 806-100CF | 10 | 11-13/16 | 17-1/16 | 11-15/16 | 40.28 |
| 806-120C | 12 | 6-7/8 | 13-7/16 | 14-5/16 | 47.93 |
| 806-120CF | 12 | 13-5/8 | 19-7/8 | 14-1/8 | 63.96 |
| 806-140C | 14 | 7-1/2 | 14-1/2 | 15-11/16 | 55.89 |
| 806-140CF | 14 | 16 | 23 | 15-1/2 | 86.72 |
| 806-160CF | 16 | 18-7/16 | 26-7/16 | 17-11/16 | 133.22 |
| 806-180CF | 18 | 20-7/8 | 29-7/8 | 19-7/8 | 175.62 |
| 806-200CF | 20 | 23-5/16 | 33-5/16 | 22-1/16 | 250.00 |
| 806-240CF | 24 | 28-1/4 | 40-1/4 | 26-7/16 | --- |



Schedule 80 CPVC Technical Information
Schedule 80 CPVC Fittings



Pumping&Plumbing

90° SWEEP ELBOW

Socket x Socket

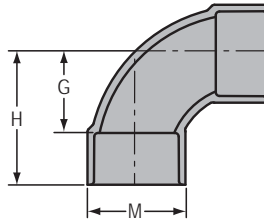

| Part Number | Size | G | H | M | Approx. Wt. (Lbs.) |
|-------------|-------|--------|---------|---------|--------------------|
| 806-005SC | 1/2 | 27/32 | 1-23/32 | 1-3/16 | .08 |
| 806-007SC | 3/4 | 1-1/32 | 2-1/32 | 1-13/32 | .12 |
| 806-010SC | 1 | 1-5/16 | 2-7/16 | 1-23/32 | .20 |
| 806-012SC | 1-1/4 | 1-9/16 | 2-13/16 | 2-3/32 | .31 |
| 806-015SC | 1-1/2 | 1-3/4 | 3-1/8 | 2-11/32 | .40 |
| 806-020SC | 2 | 2-5/16 | 3-13/16 | 2-7/8 | .68 |

90° LONG SWEEP ELBOW

Socket x Socket

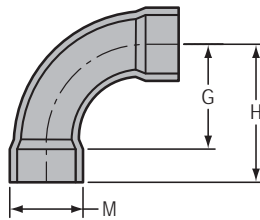

| Part Number | Size | G | H | M | Approx. Wt. (Lbs.) |
|-------------|-------|--------|--------|---------|--------------------|
| 806-005LSCF | 1/2 | 1-7/8 | 2-3/4 | 1-1/8 | .13 |
| 806-007LSCF | 3/4 | 2-7/16 | 3-7/16 | 1-7/16 | .24 |
| 806-010LSCF | 1 | 2-7/8 | 4 | 1-11/16 | .37 |
| 806-012LSCF | 1-1/4 | 3-5/8 | 4-7/8 | 2-1/16 | .56 |
| 806-015LSCF | 1-1/2 | 4-1/8 | 5-1/2 | 2-5/16 | .68 |
| 806-020LSCF | 2 | 4-3/4 | 6-5/16 | 2-13/16 | 1.07 |
| 806-025LSCF | 2-1/2 | 5-3/4 | 7-3/4 | 3-7/16 | 1.70 |
| 806-030LSCF | 3 | 7 | 9 | 4-1/8 | 2.69 |
| 806-040LSCF | 4 | 9 | 11-1/4 | 5-3/16 | 4.85 |
| 806-060LSCF | 6 | 13 | 16-1/4 | 7-1/2 | 12.84 |
| 806-080LSCF | 8 | 23-1/2 | 27-3/4 | 9-5/8 | 33.18 |





Pumping&Plumbing

Schedule 80 CPVC Technical Information
Schedule 80 CPVC Fittings

90° ELBOW

Socket x Fipt

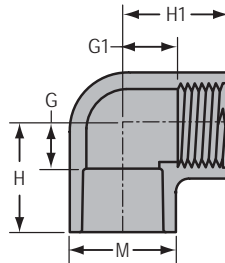

| Part Number | Size | G | G1 | H | H1 | M | Approx. Wt. (Lbs.) |
|-------------|-------|---------|--------|---------|---------|---------|--------------------|
| 807-002C | 1/4 | 5/16 | 5/16 | 15/16 | 15/16 | 7/8 | .03 |
| 807-003C | 3/8 | 1/4 | 3/8 | 1-1/32 | 1-1/32 | 1-1/32 | .05 |
| 807-005C | 1/2 | 15/32 | 9/16 | 1-11/32 | 1-9/32 | 1-3/16 | .11 |
| 807-007C | 3/4 | 5/8 | 5/8 | 1-9/16 | 1-9/16 | 1-3/8 | .11 |
| 807-010C | 1 | 11/16 | 25/32 | 1-13/16 | 1-11/16 | 1-23/32 | .19 |
| 807-012C | 1-1/4 | 23/32 | 1-1/32 | 1-31/32 | 1-31/32 | 2-1/16 | .30 |
| 807-015C | 1-1/2 | 15/16 | 1-7/32 | 2-11/32 | 2-5/32 | 2-11/32 | .46 |
| 807-020C | 2 | 15/16 | 1-1/32 | 2-7/16 | 2 | 3 | .84 |
| 807-030C | 3 | 1-27/32 | 2-7/32 | 3-23/32 | 3-9/16 | 4-9/32 | 2.02 |
| 807-040C | 4 | 2-5/16 | 2-7/8 | 4-9/16 | 4-9/32 | 5-1/4 | 2.95 |

¹ Outlet sized with Female Adapter

90°REDUCING ELBOW

Socket x Fipt

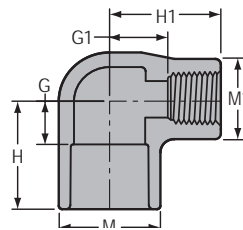

| Part Number | Size | G | G1 | H | H1 | M | M1 | Approx. Wt. (Lbs.) |
|-----------------------|---------|-------|---------|---------|---------|---------|---------|--------------------|
| 807-101C | 3/4x1/2 | 1/2 | 25/32 | 1-17/32 | 1-17/32 | 1-13/32 | 1-3/16 | .12 |
| 807-130C ¹ | 1x1/2 | 27/32 | 1-17/32 | 1-31/32 | 2-1/4 | 1-23/32 | 1-23/32 | .27 |
| 807-131C ¹ | 1x3/4 | 7/8 | 1-17/32 | 2 | 2-1/4 | 1-3/4 | 1-3/4 | .26 |

¹ Outlet sized with Female Adapter

Schedule 80 CPVC Technical Information
Schedule 80 CPVC Fittings



Pumping&Plumbing

SPECIAL REINFORCED 90° ELBOW

Socket x SR Fipt

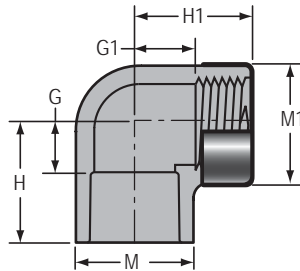

| Part Number | Size | G | G1 | H | H1 | M | M1 | Approx. Wt. (Lbs.) |
|-------------|-------|---------|---------|---------|---------|---------|---------|--------------------|
| 807-005CSR | 1/2 | 15/32 | 23/32 | 1-11/32 | 1-9/32 | 1-3/16 | 1-7/32 | .09 |
| 807-007CSR | 3/4 | 9/16 | 21/32 | 1-9/16 | 1-13/32 | 1-3/8 | 1-3/8 | .12 |
| 807-010CSR | 1 | 19/32 | 13/16 | 1-23/32 | 1-23/32 | 1-11/16 | 1-23/32 | .21 |
| 807-012CSR | 1-1/4 | 23/32 | 1-1/32 | 1-31/32 | 1-31/32 | 2-1/16 | 2-1/16 | .31 |
| 807-015CSR | 1-1/2 | 31/32 | 1-5/32 | 2-3/8 | 2-1/8 | 2-11/32 | 2-7/16 | .44 |
| 807-020CSR | 2 | 1-7/32 | 1-1/2 | 2-15/32 | 2-7/16 | 2-31/32 | 2-31/32 | .91 |
| 807-030CSR | 3 | 1-13/16 | 2-7/32 | 3-23/32 | 3-9/16 | 4-9/32 | 4-9/32 | 2.08 |
| 807-040CSR | 4 | 2-9/32 | 2-25/32 | 4-9/16 | 4-7/32 | 5-1/4 | 5-1/4 | 3.02 |

SPECIAL REINFORCED REDUCING 90° ELBOW

Socket x SR Fipt

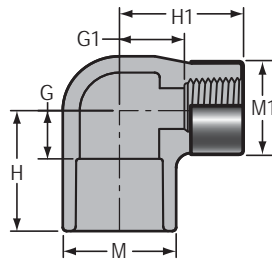

| Part Number | Size | G | G1 | H | H1 | M | M1 | Approx. Wt. (Lbs.) |
|-------------|---------|------|-------|---------|---------|---------|--------|--------------------|
| 807-101CSR | 3/4x1/2 | 1/2 | 13/16 | 1-17/32 | 1-17/32 | 1-13/32 | 1-3/16 | .12 |
| 807-130CSR | 1x1/2 | 9/16 | 1 | 1-23/32 | 1-5/8 | 1-23/32 | 1-3/16 | .14 |

TRANSITION 90° ELBOW

Socket x Brass Fipt

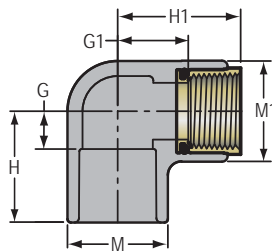

| Part Number | Size | G | G1 | H | H1 | M | M1 | Approx. Wt. (Lbs.) |
|-------------|------|-------|--------|--------|---------|--------|---------|--------------------|
| 807-005CBR | 1/2 | 13/32 | 31/32 | 1-9/32 | 1-17/32 | 1-5/32 | 1-3/16 | .15 |
| 807-007CBR | 3/4 | 1/2 | 1-5/32 | 1-1/2 | 1-25/32 | 1-3/8 | 1-13/32 | .21 |

Not intended to convey or dispense water for human consumption through drinking or cooking





Pumping & Plumbing

Schedule 80 CPVC Technical Information
Schedule 80 CPVC Fittings

TRANSITION REDUCING

90° ELBOW

Socket x Brass Fipt

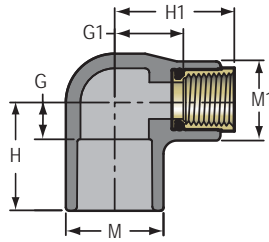

| Part Number | Size | G | G1 | H | H1 | M | M1 | Approx. Wt. (Lbs.) |
|-------------|---------|-------|--------|---------|---------|---------|--------|--------------------|
| 807-101CBR | 3/4x1/2 | 15/32 | 1-3/32 | 1-15/32 | 1-21/32 | 1-13/32 | 1-3/16 | .21 |

Not intended to convey or dispense water for human consumption through drinking or cooking

90° ELBOW

Fipt x Fipt

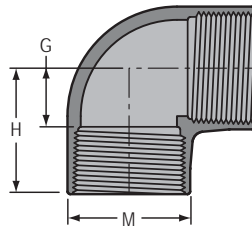

| Part Number | Size | G | H | M | Approx. Wt. (Lbs.) |
|-------------|-------|---------|---------|---------|--------------------|
| 808-002C | 1/4 | 11/32 | 15/16 | 7/8 | .04 |
| 808-003C | 3/8 | 9/16 | 1-5/32 | 15/16 | .06 |
| 808-005C | 1/2 | 1/2 | 1-7/32 | 1-9/32 | .08 |
| 808-007C | 3/4 | 5/8 | 1-3/8 | 1-3/8 | .12 |
| 808-010C | 1 | 25/32 | 1-5/8 | 1-23/32 | .21 |
| 808-012C | 1-1/4 | 15/16 | 1-7/8 | 2-1/16 | .32 |
| 808-015C | 1-1/2 | 1-5/32 | 2-3/32 | 2-7/16 | .48 |
| 808-020C | 2 | 1-9/16 | 2-17/32 | 3 | .90 |
| 808-025C | 2-1/2 | 1-5/8 | 3-3/16 | 3-9/16 | 1.26 |
| 808-030C | 3 | 1-29/32 | 3-17/32 | 4-13/32 | 2.37 |
| 808-040C | 4 | 2-13/32 | 4-5/32 | 5-7/16 | 3.44 |

SPECIAL REINFORCED

90° ELBOW

SR Fipt x SR Fipt

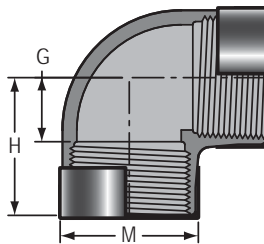

| Part Number | Size | G | H | M | Approx. Wt. (Lbs.) |
|-------------|-------|---------|---------|---------|--------------------|
| 808-003CSR | 3/8 | 9/16 | 1-5/32 | 15/16 | .07 |
| 808-005CSR | 1/2 | 1/2 | 1-7/32 | 1-3/16 | .11 |
| 808-007CSR | 3/4 | 5/8 | 1-3/8 | 1-3/8 | .14 |
| 808-010CSR | 1 | 25/32 | 1-11/16 | 1-23/32 | .24 |
| 808-012CSR | 1-1/4 | 15/16 | 1-7/8 | 2-1/16 | .36 |
| 808-015CSR | 1-1/2 | 1-1/32 | 2-1/8 | 2-7/16 | .52 |
| 808-020CSR | 2 | 1-19/32 | 2-1/2 | 3 | 1.04 |

Schedule 80 CPVC Technical Information
Schedule 80 CPVC Fittings



Pumping&Plumbing

90° STREET ELBOW

Spigot x Socket

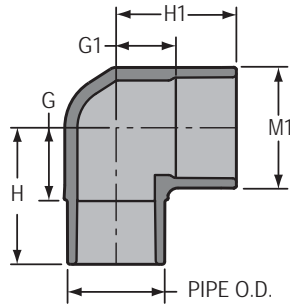

| Part Number | Size | G | G1 | H | H1 | M1 | Approx. Wt. (Lbs.) |
|-------------|-------|---------|---------|---------|---------|----------|--------------------|
| 809-005C | 1/2 | 13/16 | 7/16 | 1-21/32 | 1-7/16 | 1-5/32 | .08 |
| 809-007C | 3/4 | 29/32 | 11/16 | 1-27/32 | 1-11/16 | 1-3/8 | .12 |
| 809-010C | 1 | 1-1/16 | 3/4 | 2-7/32 | 2 | 1-23/32 | .20 |
| 809-012C | 1-1/4 | 1-9/32 | 13/16 | 2-19/32 | 2-1/4 | 2-3/32 | .31 |
| 809-015C | 1-1/2 | 1-7/16 | 1-3/16 | 2-13/16 | 2-9/16 | 2-3/8 | .43 |
| 809-020C | 2 | 1-3/4 | 1-7/16 | 3-1/4 | 2-31/32 | 2-7/8 | .64 |
| 809-025C | 2-1/2 | 2-1/2 | 1-5/8 | 4-1/2 | 3-3/8 | 3-7/16 | 1.54 |
| 809-030C | 3 | 2-3/8 | 1-13/16 | 4-1/4 | 3-11/16 | 4-3/16 | 1.70 |
| 809-040C | 4 | 3-1/32 | 2-1/4 | 5-9/32 | 4-17/32 | 5-1/4 | 2.92 |
| 809-060C | 6 | 5-1/4 | 3-11/16 | 8-7/16 | 6-3/4 | 7-9/16 | 10.01 |
| 809-080C | 8 | 7-1/8 | 4-25/32 | 11-1/8 | 8-25/32 | 9-3/4 | 18.18 |
| 809-100C | 10 | 8-5/8 | 5-13/16 | 14-5/16 | 11-3/8 | 12-1/16 | 41.05 |
| 809-120C | 12 | 10-1/8 | 6-7/8 | 16-7/8 | 13-3/8 | 14-1/8 | 67.93 |
| 809-140C | 14 | 11-1/16 | 7-9/16 | 18-5/16 | 14-5/8 | 15-11/16 | 77.21 |
| 809-140CF | 14 | 19-1/2 | 16 | 27-1/2 | 23 | 15-1/2 | 101.86 |
| 809-160CF | 16 | 22-7/16 | 18-7/16 | 31-7/16 | 26-7/16 | 17-11/16 | 135.72 |
| 809-180CF | 18 | 25-3/8 | 20-7/8 | 35-3/8 | 29-7/8 | 19-7/8 | 217.54 |
| 809-200CF | 20 | 28-5/16 | 23-5/16 | 39-5/16 | 33-5/16 | 22-1/16 | 266.40 |
| 809-240CF | 24 | 34-1/4 | 28-1/4 | 47-1/4 | 40-1/4 | 26-7/16 | 435.00 |



90° STREET ELBOW

Mipt x Fipt

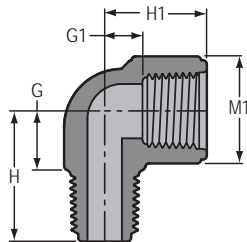

| Part Number | Size | G | G1 | H | H1 | M1 | Approx. Wt. (Lbs.) |
|-------------|------|-------|-------|---------|--------|--------|--------------------|
| 812-002C | 1/4 | 17/32 | 5/16 | 1-1/32 | 29/32 | 13/16 | .03 |
| 812-005C | 1/2 | 11/16 | 13/32 | 1-11/32 | 1-5/32 | 1-3/16 | .06 |
| 812-007C | 3/4 | 7/8 | 17/32 | 1-1/2 | 1-9/32 | 1-7/16 | .09 |



Pumping&Plumbing

Schedule 80 CPVC Technical Information
Schedule 80 CPVC Fittings

11-1/4° ELBOW

Socket x Socket

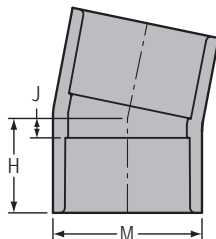

| Part Number | Size | H | J | M | Approx. Wt. (Lbs.) |
|-------------|-------|----------|---------|----------|--------------------|
| 811-015C | 1-1/2 | 1-19/32 | 7/32 | 2-3/8 | .25 |
| 811-020C | 2 | 1-23/32 | 7/32 | 2-27/32 | .35 |
| 811-025CF | 2-1/2 | 2-11/16 | 11/16 | 3-7/16 | .88 |
| 811-030C | 3 | 2-3/16 | 5/16 | 4-1/8 | .92 |
| 811-040C | 4 | 2-21/32 | 13/32 | 5-1/4 | 1.58 |
| 811-050CF | 5 | 3-13/16 | 13/16 | 6-5/16 | 3.22 |
| 811-060CF | 6 | 4-1/4 | 1 | 7-1/2 | 4.69 |
| 811-080CF | 8 | 5-3/8 | 1-1/8 | 9-5/8 | 10.52 |
| 811-100CF | 10 | 6-11/16 | 1-7/16 | 11-15/16 | 19.02 |
| 811-120CF | 12 | 7-13/16 | 1-9/16 | 14-1/8 | 29.25 |
| 811-140CF | 14 | 9 | 2 | 15-1/2 | 41.37 |
| 811-160CF | 16 | 10-3/8 | 2-3/8 | 17-11/16 | --- |
| 811-180CF | 18 | 11-3/4 | 2-3/4 | 19-7/8 | 83.44 |
| 811-200CF | 20 | 13-1/8 | 3-1/8 | 22-1/16 | 99.90 |
| 811-240CF | 24 | 15-13/16 | 3-13/16 | 26-7/16 | 196.96 |

30° ELBOW

Socket x Socket

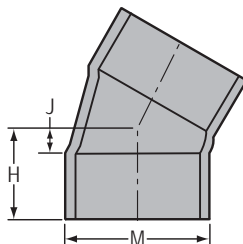

| Part Number | Size | H | J | M | Approx. Wt. (Lbs.) |
|-------------|-------|---------|--------|---------|--------------------|
| 815-005CF | 1/2 | 1-7/16 | 7/16 | 1-1/8 | .07 |
| 815-007CF | 3/4 | 1-7/16 | 7/16 | 1-3/8 | .11 |
| 815-010CF | 1 | 1-3/4 | 1/2 | 1-11/16 | .16 |
| 815-012CF | 1-1/4 | 2-3/16 | 11/16 | 2-1/16 | .24 |
| 815-015CF | 1-1/2 | 2-3/16 | 11/16 | 2-5/16 | .32 |
| 815-020CF | 2 | 2-1/2 | 3/4 | 2-13/16 | .54 |
| 815-025CF | 2-1/2 | 2-1/2 | 3/4 | 3-7/16 | .93 |
| 815-030CF | 3 | 3-5/16 | 1-1/16 | 4-1/8 | 1.44 |
| 815-040CF | 4 | 3-7/16 | 1-3/16 | 5-3/16 | 2.27 |
| 815-050CF | 5 | 4-3/8 | 1-3/8 | 6-5/16 | 3.22 |
| 815-060C | 6 | 4-13/16 | 1-7/8 | 7-9/16 | 5.89 |

Schedule 80 CPVC Technical Information
Schedule 80 CPVC Fittings



Pumping&Plumbing

30° ELBOW
 Socket x Socket (continued)

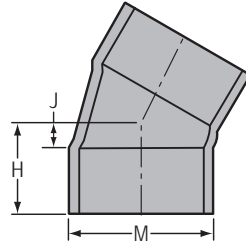

| Part Number | Size | H | J | M | Approx. Wt. (Lbs.) |
|-------------|------|----------|---------|----------|--------------------|
| 815-080CF | 8 | 6-3/16 | 1-15/16 | 9-5/8 | 11.08 |
| 815-100CF | 10 | 7-3/4 | 2-1/2 | 11-15/16 | 21.26 |
| 815-120CF | 12 | 9-1/16 | 2-13/16 | 14-1/8 | 32.33 |
| 815-140CF | 14 | 10-7/16 | 3-7/16 | 15-1/2 | 37.18 |
| 815-160CF | 16 | 11-15/16 | 3-15/16 | 17-11/16 | 64.23 |
| 815-180CF | 18 | 13-7/16 | 4-7/16 | 19-7/8 | 92.38 |
| 815-200CF | 20 | 15 | 5 | 22-1/16 | 109.89 |
| 815-240CF | 24 | 18-1/8 | 6-1/8 | 26-7/16 | 185.25 |

22-1/2° ELBOW
 Socket x Socket

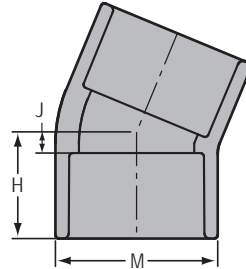

| Part Number | Size | H | J | M | Approx. Wt. (Lbs.) |
|-------------|-------|---------|-------|---------|--------------------|
| 816-005C | 1/2 | 1-1/16 | 3/16 | 1-5/32 | .06 |
| 816-007C | 3/4 | 1-3/16 | 3/16 | 1-7/16 | .09 |
| 816-010C | 1 | 1-3/8 | 9/32 | 1-23/32 | .14 |
| 816-012C | 1-1/4 | 1-1/2 | 5/16 | 2-3/32 | .20 |
| 816-015C | 1-1/2 | 1-21/32 | 1/4 | 2-3/8 | .26 |
| 816-015CF | 1-1/2 | 2-1/8 | 5/8 | 2-5/16 | .28 |
| 816-020C | 2 | 1-7/8 | 7/16 | 2-7/8 | .44 |
| 816-025C | 2-1/2 | 2-7/32 | 15/32 | 3-1/2 | .72 |
| 816-025CF | 2-1/2 | 2-7/8 | 7/8 | 3-7/16 | .84 |
| 816-030C | 3 | 2-13/32 | 9/16 | 4-5/32 | 1.01 |
| 816-040C | 4 | 2-7/8 | 5/8 | 5-1/4 | 1.71 |
| 816-050CF | 5 | 4-1/8 | 1-1/8 | 6-5/16 | 3.22 |



Pumping&Plumbing

Schedule 80 CPVC Technical Information
Schedule 80 CPVC Fittings

22-1/2° ELBOW (continued)

Socket x Socket

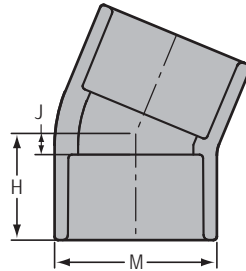

| Part Number | Size | H | J | M | Approx. Wt. (Lbs.) |
|-------------|------|---------|---------|----------|--------------------|
| 816-060C | 6 | 4-9/16 | 1-3/8 | 7-7/16 | 4.59 |
| 816-060CF | 6 | 4-5/8 | 1-3/8 | 7-1/2 | 5.29 |
| 816-080C | 8 | 5-1/16 | 1-1/32 | 9-3/4 | 8.95 |
| 816-080CF | 8 | 5-7/8 | 1-5/8 | 9-5/8 | 9.60 |
| 816-100CF | 10 | 7-5/16 | 2-1/16 | 11-15/16 | 18.77 |
| 816-120CF | 12 | 8-9/16 | 2-5/16 | 14-1/8 | 30.79 |
| 816-140CF | 14 | 9-13/16 | 2-13/16 | 15-1/2 | 40.74 |
| 816-160CF | 16 | 11-5/16 | 3-5/16 | 17-11/16 | 57.95 |
| 816-180CF | 18 | 12-3/4 | 3-3/4 | 19-7/8 | 86.42 |
| 816-200CF | 20 | 14-1/4 | 4-1/4 | 22-1/16 | 103.23 |
| 816-240CF | 24 | 17-3/16 | 5-3/16 | 26-7/16 | --- |

22-1/2° STREET ELBOW

Spigot x Socket

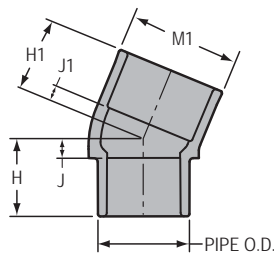

| Part Number | Size | H | H1 | J | J1 | M1 | Approx. Wt. (Lbs.) |
|-------------|-------|---------|---------|-------|-------|---------|--------------------|
| 842-005C | 1/2 | 7/8 | 1 | 1/8 | 1/8 | 1-3/16 | .05 |
| 842-007C | 3/4 | 1-1/4 | 1-5/32 | 3/16 | 3/16 | 1-3/8 | .09 |
| 842-010C | 1 | 1-7/16 | 1-11/32 | 5/16 | 7/32 | 1-23/32 | .14 |
| 842-012C | 1-1/4 | 1-9/16 | 1-9/16 | 5/16 | 3/8 | 2-3/32 | .22 |
| 842-015C | 1-1/2 | 1-21/32 | 1-7/8 | 9/32 | 1/2 | 2-3/8 | .29 |
| 842-020C | 2 | 2 | 1-29/32 | 15/32 | 13/32 | 2-7/8 | .43 |
| 842-025C | 2-1/2 | 2-7/32 | 2-7/32 | 15/32 | 15/32 | 3-1/2 | .76 |
| 842-030C | 3 | 2-1/2 | 2-5/16 | 21/32 | 7/16 | 4-5/32 | 1.00 |
| 842-040C | 4 | 2-27/32 | 3-1/32 | 9/16 | 25/32 | 5-1/4 | 2.59 |
| 842-060C | 6 | 5-11/16 | 3-15/16 | 2-3/8 | 7/8 | 7-5/8 | 6.87 |
| 842-080C | 8 | 7-3/8 | 5-1/8 | 3-1/8 | 1-1/8 | 9-3/4 | 12.71 |

Schedule 80 CPVC Technical Information
Schedule 80 CPVC Fittings



Pumping&Plumbing

45° ELBOW

Socket x Socket

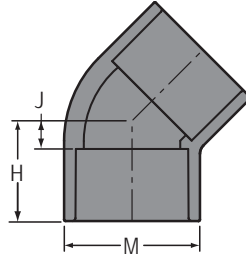

| Part Number | Size | H | J | M | Approx. Wt. (Lbs.) |
|-------------|-------|---------|---------|----------|--------------------|
| 817-002C | 1/4 | 13/16 | 5/32 | 27/32 | .03 |
| 817-003C | 3/8 | 31/32 | 7/32 | 1 | .04 |
| 817-005C | 1/2 | 1-1/8 | 1/4 | 1-3/16 | .07 |
| 817-007C | 3/4 | 1-5/16 | 5/16 | 1-7/16 | .10 |
| 817-010C | 1 | 1-7/16 | 5/16 | 1-23/32 | .16 |
| 817-012C | 1-1/4 | 1-5/8 | 3/8 | 2-1/8 | .24 |
| 817-015C | 1-1/2 | 1-13/16 | 7/16 | 2-3/8 | .32 |
| 817-020C | 2 | 2-1/8 | 5/8 | 2-7/8 | .47 |
| 817-025C | 2-1/2 | 2-13/32 | 21/32 | 3-1/2 | .82 |
| 817-030C | 3 | 2-29/32 | 29/32 | 4-5/32 | 1.16 |
| 817-040C | 4 | 3-5/16 | 1-1/16 | 5-1/4 | 2.05 |
| 817-050C | 5 | 4 | 1-11/32 | 6-13/32 | 3.31 |
| 817-050CF | 5 | 4-7/8 | 1-7/8 | 6-5/16 | 4.25 |
| 817-060C | 6 | 4-3/4 | 1-3/4 | 7-19/32 | 5.49 |
| 817-080C | 8 | 6 | 2 | 9-3/4 | 10.43 |
| 817-100C | 10 | 8-3/16 | 2-19/32 | 12-3/16 | 21.29 |
| 817-100CF | 10 | 8-11/16 | 3-7/16 | 11-15/16 | 23.50 |
| 817-120C | 12 | 9-11/16 | 3-3/32 | 14-13/32 | 35.49 |
| 817-120CF | 12 | 10-1/8 | 3-7/8 | 14-1/8 | 32.40 |
| 817-140C | 14 | 10-5/16 | 3-5/16 | 15-5/8 | 40.60 |
| 817-140CF | 14 | 11-9/16 | 4-9/16 | 15-1/2 | 41.37 |
| 817-160CF | 16 | 13-5/16 | 5-5/16 | 17-11/16 | 57.91 |
| 817-180CF | 18 | 15 | 6 | 19-7/8 | 88.48 |
| 817-200CF | 20 | 16-3/4 | 6-3/4 | 22-1/16 | 123.21 |
| 817-240CF | 24 | 20-3/16 | 8-3/16 | 26-7/16 | --- |





Pumping&Plumbing

Schedule 80 CPVC Technical Information
Schedule 80 CPVC Fittings

15° ELBOW
 Socket x Socket

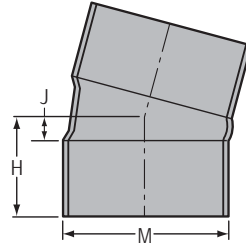

| Part Number | Size | H | J | M | Approx. Wt. (Lbs.) |
|-------------|-------|----------|---------|----------|--------------------|
| 818-020CF | 2 | 2-5/16 | 9/16 | 2-13/16 | .54 |
| 818-025CF | 2-1/2 | 2-3/4 | 3/4 | 3-7/16 | .69 |
| 818-030CF | 3 | 3 | 3/4 | 4-1/8 | 1.44 |
| 818-040CF | 4 | 3-1/8 | 7/8 | 5-3/16 | 1.96 |
| 818-050CF | 5 | 3-15/16 | 15/16 | 6-5/16 | 3.22 |
| 818-060CF | 6 | 4-3/8 | 1-1/8 | 7-1/2 | 5.38 |
| 818-080CF | 8 | 4-1/2 | 1-1/4 | 9-5/8 | 10.52 |
| 818-100CF | 10 | 6-15/16 | 1-11/16 | 11-15/16 | 19.02 |
| 818-120CF | 12 | 8-1/16 | 1-13/16 | 14-1/8 | 29.25 |
| 818-140CF | 14 | 9-5/16 | 2-5/16 | 15-1/2 | 40.75 |
| 818-160CF | 16 | 10-11/16 | 2-11/16 | 17-11/16 | 59.47 |
| 818-180CF | 18 | 12-1/16 | 3-1/16 | 19-7/8 | 83.44 |
| 818-200CF | 20 | 13-1/2 | 3-1/2 | 22-1/16 | 99.90 |
| 818-240CF | 24 | 16-1/4 | 4-1/4 | 26-7/16 | 202.28 |



Schedule 80 CPVC Technical Information
Schedule 80 CPVC Fittings



Pumping&Plumbing

45° ELBOW

Fipt x Fipt

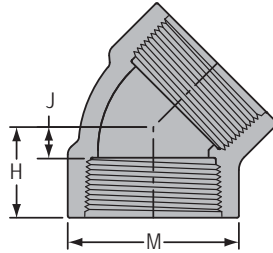

| Part Number | Size | H | J | M | Approx. Wt. (Lbs.) |
|-------------|-------|---------|--------|---------|--------------------|
| 819-002C | 1/4 | 25/32 | 3/16 | 27/32 | .03 |
| 819-003C | 3/8 | 13/16 | 3/16 | 1 | .04 |
| 819-005C | 1/2 | 31/32 | 5/16 | 1-3/16 | .08 |
| 819-007C | 3/4 | 1-3/32 | 13/32 | 1-3/8 | .07 |
| 819-010C | 1 | 1-7/32 | 7/32 | 1-11/16 | .15 |
| 819-012C | 1-1/4 | 1-7/16 | 7/16 | 2-3/16 | .25 |
| 819-015C | 1-1/2 | 1-1/2 | 15/32 | 2-1/2 | .33 |
| 819-020C | 2 | 1-23/32 | 21/32 | 3 | .48 |
| 819-025C | 2-1/2 | 2-17/32 | 31/32 | 3-1/2 | 1.24 |
| 819-030C | 3 | 2-23/32 | 1 | 4-9/32 | 1.92 |
| 819-040C | 4 | 3-1/4 | 1-7/32 | 5-1/4 | 2.79 |



SPECIAL REINFORCED 45° ELBOW

SR Fipt x SR Fipt

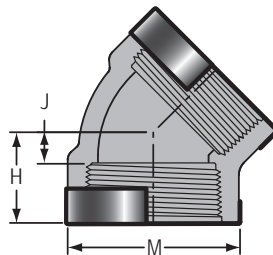

| Part Number | Size | H | J | M | Approx. Wt. (Lbs.) |
|-------------|------|-------|-------|---------|--------------------|
| 819-005CSR | 1/2 | 1 | 5/16 | 1-3/16 | .09 |
| 819-007CSR | 3/4 | 1-1/8 | 13/32 | 1-3/8 | .11 |
| 819-010CSR | 1 | 1-1/4 | 13/32 | 1-23/32 | .18 |



Pumping&Plumbing

Schedule 80 CPVC Technical Information
Schedule 80 CPVC Fittings

60° ELBOW

Socket x Socket

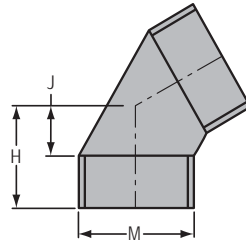

| Part Number | Size | H | J | M | Approx. Wt. (Lbs.) |
|-------------|-------|----------|---------|----------|--------------------|
| 824-005CF | 1/2 | 1-5/8 | 5/8 | 1-1/8 | .14 |
| 824-007CF | 3/4 | 1-11/16 | 11/16 | 1-3/8 | .09 |
| 824-010CF | 1 | 2 | 3/4 | 1-11/16 | .34 |
| 824-012CF | 1-1/4 | 2-1/2 | 1 | 2-1/16 | .69 |
| 824-015CF | 1-1/2 | 2-5/8 | 1-1/8 | 1-3/8 | .37 |
| 824-020CF | 2 | 3 | 1-1/4 | 2-13/16 | .59 |
| 824-025CF | 2-1/2 | 3-9/16 | 1-9/16 | 3-7/16 | .95 |
| 824-030CF | 3 | 4 | 1-3/4 | 4-1/8 | 1.34 |
| 824-040CF | 4 | 4-5/16 | 2-1/16 | 5-3/16 | 5.10 |
| 824-050CF | 5 | 5-3/8 | 2-3/8 | 6-5/16 | 7.39 |
| 824-060CF | 6 | 6-1/8 | 2-7/8 | 7-1/2 | 10.87 |
| 824-080CF | 8 | 7-3/4 | 3-1/2 | 9-5/8 | 19.49 |
| 824-100CF | 10 | 9-11/16 | 4-7/16 | 11-15/16 | 36.34 |
| 824-120CF | 12 | 11-5/16 | 5-1/16 | 14-1/8 | 63.05 |
| 824-140CF | 14 | 12-15/16 | 5-15/16 | 15-1/2 | 88.90 |
| 824-160CF | 16 | 14-13/16 | 6-13/16 | 17-11/16 | 126.09 |
| 824-180CF | 18 | 16-3/4 | 7-3/4 | 19-7/8 | 175.82 |
| 824-200CF | 20 | 26-5/8 | 16-5/8 | 22-1/16 | 247.63 |
| 824-240CF | 24 | 32-1/8 | 20-1/8 | 26-7/16 | 362.00 |

45° STREET ELBOW

Spigot x Socket

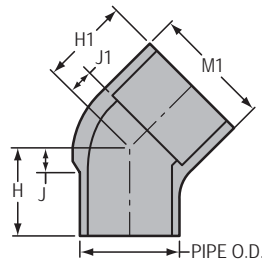

| Part Number | Size | H | H1 | J | J1 | M1 | Approx. Wt. (Lbs.) |
|-------------|-------|---------|---------|---------|--------|---------|--------------------|
| 827-005C | 1/2 | 1-9/32 | 1-5/16 | 11/32 | 7/16 | 1-3/16 | .06 |
| 827-007C | 3/4 | 1-1/2 | 1-1/2 | 7/16 | 1/2 | 1-13/32 | .10 |
| 827-010C | 1 | 1-25/32 | 1-1/2 | 19/32 | 3/8 | 1-3/4 | .16 |
| 827-012C | 1-1/4 | 2 | 1-23/32 | 5/8 | 15/32 | 2-3/32 | .24 |
| 827-015C | 1-1/2 | 2-1/32 | 2-1/8 | 19/32 | 25/32 | 2-11/32 | .32 |
| 827-020C | 2 | 2-5/16 | 2-11/32 | 11/16 | 3/8 | 2-27/32 | .47 |
| 827-025C | 2-1/2 | 3-11/16 | 2-9/16 | 1-11/16 | 13/16 | 3-1/2 | 1.29 |
| 827-030C | 3 | 3-1/4 | 2-13/16 | 1-3/16 | 29/32 | 4-5/32 | 1.25 |
| 827-040C | 4 | 3-13/16 | 3-13/16 | 1-9/32 | 1-9/16 | 5-1/4 | 2.20 |
| 827-060C | 6 | 5-3/32 | 4-25/32 | 2-1/16 | 2-1/16 | 7-19/32 | 5.91 |
| 827-080C | 8 | 6-5/8 | 5-31/32 | 2-19/32 | 1-3/4 | 9-3/4 | 10.51 |

Schedule 80 CPVC Technical Information
Schedule 80 CPVC Fittings



Pumping&Plumbing

45° STREET ELBOW (continued)

Spigot x Socket

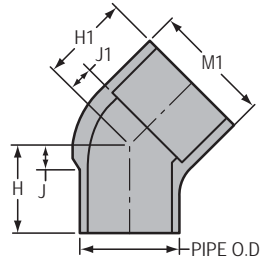

| Part Number | Size | H | H1 | J | J1 | M1 | Approx. Wt. (Lbs.) |
|-------------|------|----------|---------|---------|--------|----------|--------------------|
| 827-100C | 10 | 10-21/32 | 8-3/16 | 2-19/32 | 5-5/16 | 12-3/16 | 26.59 |
| 827-120C | 12 | 13-1/4 | 9-11/16 | 6-3/8 | 3-3/32 | 14-13/32 | 46.00 |
| 827-140CF | 14 | 11-9/16 | 11-9/16 | 4-9/16 | 4-9/16 | 15-1/2 | 70.37 |
| 827-160CF | 16 | 18-5/16 | 13-5/16 | 9-5/16 | 5-5/16 | 17-11/16 | 90.40 |
| 827-180CF | 18 | 20-1/2 | 15 | 10-1/2 | 6 | 19-7/8 | 131.12 |
| 827-200CF | 20 | 22-3/4 | 16-3/4 | 11-3/4 | 6-3/4 | 22-1/16 | 153.18 |
| 827-240CF | 24 | 27-3/16 | 20-3/16 | 14-3/16 | 8-3/16 | 26-7/16 | --- |

CROSS

Socket x Socket x Socket x Socket

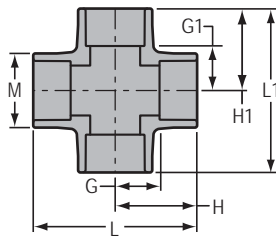

| Part Number | Size | G | G1 | H | H1 | L | L1 | M | Approx. Wt. (Lbs.) |
|-------------|-------|---------|---------|---------|---------|---------|---------|----------|--------------------|
| 820-002C | 1/4 | 13/32 | 13/32 | 1-1/32 | 1-1/32 | 2-1/16 | 2-1/16 | 27/32 | .05 |
| 820-005C | 1/2 | 9/16 | 9/16 | 1-15/32 | 1-15/32 | 2-15/16 | 2-15/16 | 1-3/16 | .13 |
| 820-007C | 3/4 | 5/8 | 5/8 | 1-5/8 | 1-5/8 | 3-9/32 | 3-9/32 | 1-13/32 | .21 |
| 820-010C | 1 | 31/32 | 31/32 | 2-3/32 | 2-3/32 | 4-7/32 | 4-7/32 | 1-23/32 | .46 |
| 820-012C | 1-1/4 | 1-3/32 | 1-3/32 | 2-3/8 | 2-3/8 | 4-3/4 | 4-3/4 | 2-1/8 | .65 |
| 820-015C | 1-1/2 | 1-1/4 | 1-1/4 | 2-5/8 | 2-5/8 | 5-1/4 | 5-1/4 | 2-3/8 | .81 |
| 820-020C | 2 | 1-1/2 | 1-1/2 | 3 | 3 | 6 | 6 | 3 | 1.38 |
| 820-025C | 2-1/2 | 1-11/16 | 1-11/16 | 3-15/32 | 3-15/32 | 6-29/32 | 6-29/32 | 3-17/32 | 2.11 |
| 820-030C | 3 | 2-3/32 | 2-3/32 | 3-31/32 | 3-31/32 | 7-15/16 | 7-15/16 | 4-11/32 | 3.39 |
| 820-040C | 4 | 2-5/8 | 2-5/8 | 4-7/8 | 4-7/8 | 9-3/4 | 9-3/4 | 5-11/32 | 5.30 |
| 820-050CF | 5 | 5-1/2 | 5-1/2 | 8-1/2 | 8-1/2 | 17 | 17 | 6-5/16 | 15.06 |
| 820-060CF | 6 | 6-1/4 | 6-1/4 | 9-1/2 | 9-1/2 | 19 | 19 | 7-1/2 | 16.94 |
| 820-080CF | 8 | 7-5/8 | 7-5/8 | 11-7/8 | 11-7/8 | 23-3/4 | 23-3/4 | 9-5/8 | 40.50 |
| 820-100CF | 10 | 9 | 9 | 14-1/4 | 14-1/4 | 28-1/2 | 28-1/2 | 11-15/16 | 67.20 |
| 820-120CF | 12 | 11-1/4 | 11-1/4 | 17-1/2 | 17-1/2 | 35 | 35 | 14-1/8 | 107.80 |
| 820-140CF | 14 | 12-1/4 | 12-1/4 | 19-1/4 | 19-1/4 | 38-1/2 | 38-1/2 | 15-1/2 | 148.16 |
| 820-160CF | 16 | 13 | 13 | 21 | 21 | 42 | 42 | 17-11/16 | 180.80 |
| 820-180CF | 18 | 13-3/4 | 13-3/4 | 22-3/4 | 22-3/4 | 45-1/2 | 45-1/2 | 19-7/8 | 198.00 |
| 820-200CF | 20 | 16-3/8 | 16-3/8 | 26-3/8 | 26-3/8 | 52-3/4 | 52-3/4 | 22-1/16 | 249.75 |
| 820-240CF | 24 | 20-1/4 | 20-1/4 | 32-1/4 | 32-1/4 | 64-1/2 | 64-1/2 | 26-7/16 | 355.98 |





Pumping&Plumbing

Schedule 80 CPVC Technical Information
Schedule 80 CPVC Fittings

REDUCING CROSS

Socket x Socket x Socket x Socket

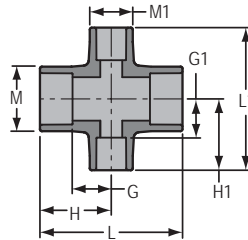

| Part Number | Size | G | G1 | H | H1 | L | L1 | M | M1 | Approx. Wt. (Lbs.) |
|-----------------------|-------------------------|---------|----------|---------|----------|---------|----------|----------|----------|--------------------|
| 820-130C ¹ | 1x1x1/2x1/2 | 1 | 1-7/16 | 2-1/8 | 2-3/8 | 4-7/32 | 4-3/4 | 1-23/32 | 1-23/32 | .59 |
| 820-131C | 1x1x1/2x3/4 | 23/32 | 5/8 | 1-5/8 | 1-5/8 | 3-1/4 | 3-1/4 | 1-7/8 | 1-1/2 | .31 |
| 820-166C ¹ | 1-1/4x1-1/4x1/2x1/2 | 1-3/32 | 1-3/32 | 2-3/8 | 2-11/16 | 4-3/4 | 5-3/16 | 3-3/32 | 3-3/32 | .84 |
| 820-167C | 1-1/4x1-1/4x3/4x3/4 | 1-1/16 | 23/32 | 2-1/16 | 1-31/32 | 4-3/32 | 3-31/32 | 2-1/16 | 1-13/32 | .35 |
| 820-209C ¹ | 1-1/2x1-1/2x1/2x1/2 | 1-7/32 | 1-7/32 | 2-21/32 | 2-31/32 | 5-1/4 | 5-15/16 | 2-3/8 | 2-3/8 | 1.21 |
| 820-210C | 1-1/2x1-1/2x3/4x3/4 | 11/16 | 1-5/32 | 2-3/32 | 2-3/16 | 4-3/16 | 4-11/32 | 2-3/8 | 1-13/32 | .42 |
| 820-211C ¹ | 1-1/2x1-1/2x1x1 | 1-3/4 | 1-3/4 | 2-5/8 | 3 | 5-5/16 | 5-7/8 | 1-3/8 | 1-3/8 | 1.16 |
| 820-248C | 2x2x3/4x3/4 | 11/16 | 1-7/16 | 2-7/32 | 2-7/16 | 4-13/32 | 4-7/8 | 2-29/32 | 1-13/32 | .56 |
| 820-249C ¹ | 2x2x1x1 | 1-1/2 | 2-9/32 | 3 | 3-7/16 | 6 | 6-27/32 | 3 | 3 | 1.99 |
| 820-289C | 2-1/2x2-1/2x1x1 | 7/8 | 1-23/32 | 2-11/16 | 2-7/8 | 5-11/32 | 5-3/4 | 3-1/2 | 1-3/4 | 1.00 |
| 820-291C ¹ | 2-1/2x2-1/2x1-1/2x1-1/2 | 1-11/16 | 2-15/32 | 3-7/16 | 3-27/32 | 6-7/8 | 7-23/32 | 3-9/16 | 3-9/16 | 2.97 |
| 820-336C ¹ | 3x3x1-1/4x1-1/4 | 2-3/32 | 3-1/8 | 3-31/32 | 4-3/8 | 7-29/32 | 8-3/4 | 4-3/16 | 4-3/16 | 4.46 |
| 820-338C ¹ | 3x3x2x2 | 2-3/32 | 2-27/32 | 3-31/32 | 4-5/16 | 7-29/32 | 8-5/8 | 4-13/32 | 4-5/16 | 4.46 |
| 820-420C ¹ | 4x4x2x2 | 2-5/8 | 3-13/16 | 4-7/8 | 5-11/32 | 9-3/4 | 10-21/32 | 5-11/32 | 5-7/32 | 7.83 |
| 820-420CF | 4x4x2x2 | 3-7/8 | 4-1/4 | 6-1/8 | 6 | 12-1/4 | 12 | 5-3/16 | 2-13/16 | 5.79 |
| 820-422C ¹ | 4x4x3x3 | 2-5/8 | 3-7/16 | 4-7/8 | 5-5/16 | 9-3/4 | 10-5/8 | 5-1/4 | 5-1/4 | 7.21 |
| 820-528CF | 6x6x2x2 | 4-5/8 | 5-3/16 | 7-7/8 | 6-15/16 | 15-3/4 | 13-7/8 | 7-1/2 | 2-13/16 | 8.70 |
| 820-530CF | 6x6x3x3 | 4-3/4 | 5-3/4 | 8 | 8 | 16 | 16 | 7-1/2 | 4-1/8 | 10.24 |
| 820-532CF | 6x6x4x4 | 5-1/4 | 6-3/4 | 8-1/2 | 9 | 17 | 18 | 7-1/2 | 5-3/16 | 15.93 |
| 820-533CF | 6x6x5x5 | 5-3/4 | 6-1/2 | 9 | 9-1/2 | 18 | 19 | 7-1/2 | 6-5/16 | 14.41 |
| 820-578CF | 8x8x2x2 | 4-11/16 | 6-1/8 | 8-15/16 | 7-7/8 | 17-7/8 | 15-3/4 | 9-5/8 | 2-13/16 | 15.90 |
| 820-580CF | 8x8x3x3 | 5-3/16 | 6-11/16 | 9-7/16 | 8-15/16 | 18-7/8 | 17-7/8 | 9-5/8 | 4-1/8 | 13.77 |
| 820-582CF | 8x8x4x4 | 5-3/4 | 7-11/16 | 10 | 9-15/16 | 20 | 19-7/8 | 9-5/8 | 5-3/16 | 24.71 |
| 820-585CF | 8x8x6x6 | 6-3/4 | 8-1/16 | 11 | 11-5/16 | 22 | 22-5/8 | 9-5/8 | 7-1/2 | 30.75 |
| 820-621CF | 10x10x2x2 | 4-3/8 | 7-1/8 | 9-5/8 | 8-7/8 | 19-1/4 | 17-11/16 | 11-15/16 | 2-13/16 | 27.78 |
| 820-623CF | 10x10x3x3 | 4-7/8 | 7-11/16 | 10-1/8 | 9-15/16 | 20-1/4 | 19-13/16 | 11-15/16 | 4-1/8 | 30.16 |
| 820-624CF | 10x10x4x4 | 5-3/8 | 8-11/16 | 10-5/8 | 10-15/16 | 21-1/4 | 21-13/16 | 11-15/16 | 5-3/16 | 28.17 |
| 820-626CF | 10x10x6x6 | 5-7/8 | 9-1/16 | 11-1/8 | 12-5/16 | 22-1/4 | 24-5/8 | 11-15/16 | 7-1/2 | 38.61 |
| 820-628CF | 10x10x8x8 | 8-1/4 | 9-15/16 | 13-1/2 | 14-3/16 | 27 | 28-3/8 | 11-15/16 | 9-5/8 | 59.10 |
| 820-661CF | 12x12x2x2 | 4-3/4 | 8 | 11 | 9-3/4 | 22 | 19-1/2 | 14-1/8 | 2-13/16 | 44.02 |
| 820-663CF | 12x12x3x3 | 5-1/4 | 8-9/16 | 11-1/2 | 10-13/16 | 23 | 21-5/8 | 14-1/8 | 4-1/8 | 45.28 |
| 820-664CF | 12x12x4x4 | 5-3/4 | 9-9/16 | 12 | 11-13/16 | 24 | 23-5/8 | 14-1/8 | 5-3/16 | 42.60 |
| 820-666CF | 12x12x6x6 | 7-1/4 | 9-15/16 | 13-1/4 | 13-3/16 | 26-1/2 | 26-3/8 | 14-1/8 | 7-1/2 | 61.56 |
| 820-668CF | 12x12x8x8 | 8 | 10-13/16 | 14-1/4 | 15-1/16 | 28-1/2 | 30-1/8 | 14-1/8 | 9-5/8 | 73.35 |
| 820-670CF | 12x12x10x10 | 10-1/4 | 10-13/16 | 16-1/2 | 16-1/16 | 33 | 32-1/8 | 14-1/8 | 11-15/16 | 78.03 |
| 820-691CF | 14x14x2x2 | 5-3/16 | 8-9/16 | 12-3/16 | 10-5/16 | 24-3/8 | 20-5/8 | 15-1/2 | 2-13/16 | 45.02 |

¹ Outlet sized with bushing

Schedule 80 CPVC Technical Information
Schedule 80 CPVC Fittings



Pumping&Plumbing

REDUCING CROSS (continued)

Socket x Socket x Socket x Socket

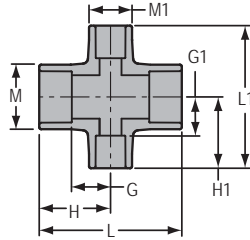

| Part Number | Size | G | G1 | H | H1 | L | L1 | M | M1 | Approx. Wt. (Lbs.) |
|-------------|-------------------|---------|----------|----------|----------|--------|--------|----------|----------|--------------------|
| 820-693CF | 14x14x3x3 | 5-3/4 | 9-1/8 | 12-3/4 | 11-3/8 | 25-1/2 | 22-3/4 | 15-1/2 | 4-1/8 | 57.57 |
| 820-694CF | 14x14x4x4 | 6-1/2 | 10-1/8 | 13-1/2 | 12-3/8 | 27 | 24-3/4 | 15-1/2 | 5-3/16 | 69.17 |
| 820-696CF | 14x14x6x6 | 8-1/4 | 10-1/2 | 15-1/4 | 13-3/4 | 30-1/2 | 27-1/2 | 15-1/2 | 7-1/2 | 63.15 |
| 820-698CF | 14x14x8x8 | 9-1/4 | 11-3/8 | 16-1/4 | 15-5/8 | 32-1/2 | 31-1/4 | 15-1/2 | 9-5/8 | 68.17 |
| 820-700CF | 14x14x10x10 | 10-1/8 | 11-3/8 | 17-1/8 | 16-5/8 | 34-1/4 | 33-1/4 | 15-1/2 | 11-15/16 | 89.80 |
| 820-702CF | 14x14x12x12 | 11 | 11-3/8 | 18 | 17-5/8 | 36 | 35-1/4 | 15-1/2 | 14-1/8 | 93.81 |
| 820-751CF | 16x16x2x2 | 5-7/8 | 9-1/2 | 13-7/8 | 11-1/4 | 27-3/4 | 22-1/2 | 17-11/16 | 2-13/16 | 71.71 |
| 820-752CF | 16x16x2-1/2x2-1/2 | 6 | 9-11/16 | 14 | 11-11/16 | 28 | 23-3/8 | 17-11/16 | 3-7/16 | 65.37 |
| 820-753CF | 16x16x3x3 | 6-5/16 | 10-1/16 | 14-5/16 | 12-5/16 | 28-5/8 | 24-5/8 | 17-11/16 | 4-1/8 | 67.39 |
| 820-754CF | 16x16x4x4 | 6-1/8 | 11-1/16 | 14-1/8 | 13-5/16 | 28-1/4 | 26-5/8 | 17-11/16 | 5-3/16 | 70.21 |
| 820-756CF | 16x16x6x6 | 8-5/8 | 11-7/16 | 16-5/8 | 14-11/16 | 33-1/4 | 29-3/8 | 17-11/16 | 7-1/2 | 90.09 |
| 820-758CF | 16x16x8x8 | 9-5/8 | 12-5/16 | 17-5/8 | 16-9/16 | 35-1/4 | 33-1/8 | 17-11/16 | 9-5/8 | 98.69 |
| 820-760CF | 16x16x10x10 | 10-5/8 | 12-5/16 | 18-5/8 | 17-9/16 | 37-1/4 | 35-1/8 | 17-11/16 | 11-15/16 | 103.85 |
| 820-762CF | 16x16x12x12 | 11-5/8 | 12-5/16 | 19-5/8 | 18-9/16 | 39-1/4 | 37-1/8 | 17-11/16 | 14-1/8 | 116.70 |
| 820-764CF | 16x16x14x14 | 12-3/4 | 12-11/16 | 20-3/4 | 19-11/16 | 41-1/2 | 39-3/8 | 17-11/16 | 15-1/2 | 135.00 |
| 820-784CF | 18x18x4x4 | 6-7/8 | 11-15/16 | 15-7/8 | 14-3/16 | 31-3/4 | 28-3/8 | 19-7/8 | 5-3/16 | 99.22 |
| 820-786CF | 18x18x6x6 | 8-1/2 | 12-5/16 | 17-1/2 | 15-9/16 | 35 | 31-1/8 | 19-7/8 | 7-1/2 | 122.13 |
| 820-788CF | 18x18x8x8 | 9-1/2 | 13-3/16 | 18-1/2 | 17-7/16 | 37 | 34-7/8 | 19-7/8 | 9-5/8 | 135.00 |
| 820-790CF | 18x18x10x10 | 10-1/2 | 13-3/16 | 19-1/2 | 18-7/16 | 39 | 36-7/8 | 19-7/8 | 11-15/16 | 150.90 |
| 820-792CF | 18x18x12x12 | 11-1/2 | 13-3/16 | 20-1/2 | 19-7/16 | 41 | 38-7/8 | 19-7/8 | 14-1/8 | 169.57 |
| 820-794CF | 18x18x14x14 | 12-3/4 | 13-9/16 | 21-3/4 | 20-9/16 | 43-1/2 | 41-1/8 | 19-11/16 | 15-1/2 | 165.78 |
| 820-796CF | 18x18x16x16 | 13-1/2 | 14-3/16 | 22-1/2 | 22-3/16 | 45 | 44-3/8 | 19-11/16 | 17-11/16 | 172.46 |
| 820-814CF | 20x20x4x4 | 7-11/16 | 12-7/8 | 17-11/16 | 15-1/8 | 35-3/8 | 30-1/4 | 22-1/16 | 5-3/16 | 116.55 |
| 820-816CF | 20x20x6x6 | 8-7/8 | 13-1/4 | 18-7/8 | 16-1/2 | 37-3/4 | 33 | 22-1/16 | 7-1/2 | 140.98 |
| 820-818CF | 20x20x8x8 | 9-7/8 | 14-1/8 | 19-7/8 | 18-3/8 | 39-3/4 | 36-3/4 | 22-1/16 | 9-5/8 | 151.48 |
| 820-820CF | 20x20x10x10 | 10-7/8 | 14-1/8 | 20-7/8 | 19-3/8 | 41-3/4 | 38-3/4 | 22-1/16 | 11-15/16 | 163.28 |
| 820-822CF | 20x20x12x12 | 11-7/8 | 14-1/8 | 21-7/8 | 20-3/8 | 43-3/4 | 40-3/4 | 22-1/16 | 14-1/8 | 176.50 |
| 820-824CF | 20x20x14x14 | 12-7/8 | 14-1/2 | 22-7/8 | 21-1/2 | 45-3/4 | 43 | 22-1/16 | 15-1/2 | 190.95 |
| 820-826CF | 20x20x16x16 | 14 | 15-1/8 | 24 | 23-1/8 | 48 | 46-1/4 | 22-1/16 | 17-11/16 | 210.27 |
| 820-828CF | 20x20x18x18 | 15 | 15 | 25 | 24 | 50 | 48 | 22-1/16 | 19-7/8 | 226.80 |
| 820-904CF | 24x24x4x4 | 9 | 14-11/16 | 21 | 16-15/16 | 42 | 33-7/8 | 26-7/16 | 5-3/16 | 195.97 |
| 820-906CF | 24x24x6x6 | 9-1/4 | 15-1/16 | 21-1/4 | 18-5/16 | 42-1/2 | 36-5/8 | 26-7/16 | 7-1/2 | 202.94 |
| 820-908CF | 24x24x8x8 | 10-1/4 | 15-15/16 | 22-1/4 | 20-3/16 | 44-1/2 | 40-3/8 | 26-7/16 | 9-5/8 | 236.29 |
| 820-910CF | 24x24x10x10 | 11-1/4 | 15-15/16 | 23-1/4 | 21-3/16 | 46-1/2 | 42-3/8 | 26-7/16 | 11-15/16 | 255.96 |





Pumping&Plumbing

Schedule 80 CPVC Technical Information
Schedule 80 CPVC Fittings

REDUCING CROSS (continued)

Socket x Socket x Socket x Socket

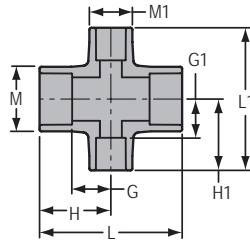

| Part Number | Size | G | G1 | H | H1 | L | L1 | M | M1 | Approx. Wt. (Lbs.) |
|-------------|-------------|--------|----------|--------|----------|--------|--------|---------|----------|--------------------|
| 820-912CF | 24x24x12x12 | 12-1/4 | 15-15/16 | 24-1/4 | 22-3/16 | 48-1/2 | 44-3/8 | 26-7/16 | 14-1/8 | 280.93 |
| 820-914CF | 24x24x14x14 | 13-1/4 | 16-5/16 | 25-1/4 | 23-5/16 | 50-1/2 | 46-5/8 | 26-1/16 | 15-1/2 | 282.43 |
| 820-916CF | 24x24x16x16 | 14-3/4 | 16-15/16 | 26-3/4 | 24-15/16 | 53-1/2 | 49-7/8 | 26-7/16 | 17-11/16 | 306.44 |
| 820-918CF | 24x24x18x18 | 15-3/4 | 16-13/16 | 27-3/4 | 25-13/16 | 55-1/2 | 51-5/8 | 26-7/16 | 19-7/8 | 246.78 |
| 820-920CF | 24x24x20x20 | 16-3/4 | 18-3/16 | 28-3/4 | 28-3/16 | 57-1/2 | 56-3/8 | 26-7/16 | 22-1/16 | 351.60 |

COUPLING

Socket x Socket

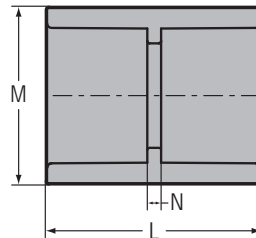

| Part Number | Size | L | M | N | Approx. Wt. (Lbs.) |
|-------------|-------|---------|----------|------|--------------------|
| 829-002C | 1/4 | 1-3/8 | 27/32 | 1/16 | .02 |
| 829-003C | 3/8 | 1-5/8 | 1 | 3/32 | .04 |
| 829-005C | 1/2 | 1-7/8 | 1-3/16 | 1/8 | .07 |
| 829-007C | 3/4 | 2-1/8 | 1-13/32 | 1/8 | .10 |
| 829-010C | 1 | 2-15/32 | 1-23/32 | 3/16 | .13 |
| 829-012C | 1-1/4 | 2-23/32 | 2-7/32 | 7/32 | .23 |
| 829-015C | 1-1/2 | 2-7/8 | 2-11/32 | 3/32 | .22 |
| 829-020C | 2 | 3-1/8 | 2-27/32 | 3/32 | .32 |
| 829-025C | 2-1/2 | 3-11/16 | 3-15/32 | 1/4 | .58 |
| 829-030C | 3 | 3-31/32 | 4-5/32 | 3/16 | .82 |
| 829-040C | 4 | 4-3/4 | 5-5/16 | 1/4 | 1.36 |
| 829-050C | 5 | 5-21/32 | 6-3/8 | 3/16 | 2.21 |
| 829-050CF | 5 | 8 | 6-5/16 | 2 | 2.32 |
| 829-060C | 6 | 6-3/8 | 7-9/16 | 1/4 | 3.93 |
| 829-080C | 8 | 8-1/4 | 9-23/32 | 9/32 | 6.95 |
| 829-100C | 10 | 10-9/32 | 12-1/16 | 1/4 | 12.31 |
| 829-100CF | 10 | 12-1/2 | 11-15/16 | 2 | 16.78 |
| 829-120C | 12 | 12-3/8 | 14-7/32 | 3/8 | 20.05 |

Schedule 80 CPVC Technical Information
Schedule 80 CPVC Fittings



Pumping&Plumbing

COUPLING (continued)

Socket x Socket

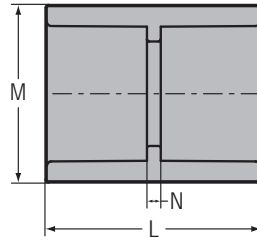

| Part Number | Size | L | M | N | Approx. Wt. (Lbs.) |
|-------------|------|---------|----------|-------|--------------------|
| 829-120CF | 12 | 15-1/4 | 14-1/8 | 2-3/4 | 27.71 |
| 829-140C | 14 | 14-7/16 | 15-5/8 | 3/8 | 28.11 |
| 829-140CF | 14 | 16 | 15-1/2 | 2 | 33.33 |
| 829-160CF | 16 | 18-5/8 | 17-11/16 | 2-5/8 | 42.93 |
| 829-180CF | 18 | 22 | 19-7/8 | 4 | 72.89 |
| 829-200CF | 20 | 23-3/4 | 22-1/16 | 3-3/4 | 99.56 |
| 829-240CF | 24 | 29-1/4 | 26-7/16 | 5-1/4 | --- |

REDUCER COUPLING

Socket x Socket

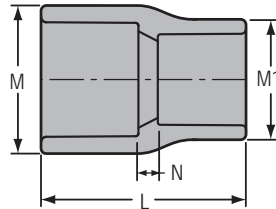

| Part Number | Size | L | M | M1 | N | Approx. Wt. (Lbs.) |
|-----------------------|-------------|---------|---------|---------|-------|--------------------|
| 829-101C | 3/4x1/2 | 2-3/32 | 1-13/32 | 1-5/32 | 7/32 | .07 |
| 829-130C | 1x1/2 | 2-3/16 | 1-23/32 | 1-13/32 | 7/32 | .12 |
| 829-131C | 1x3/4 | 2-13/32 | 1-23/32 | 1-13/32 | 1/4 | .10 |
| 829-166C | 1-1/4x1/2 | 2-9/16 | 2-3/32 | 1-5/32 | 7/16 | .15 |
| 829-167C | 1-1/4x3/4 | 2-19/32 | 2-3/32 | 1-5/8 | 11/32 | .18 |
| 829-168C | 1-1/4x1 | 2-11/16 | 2-1/8 | 1-3/4 | 5/16 | .15 |
| 829-209C | 1-1/2x1/2 | 2-27/32 | 2-11/32 | 1-3/16 | 19/32 | .20 |
| 829-210C | 1-1/2x3/4 | 2-7/8 | 2-3/8 | 1-13/32 | 17/32 | .19 |
| 829-211C | 1-1/2x1 | 2-7/8 | 2-11/32 | 1-15/16 | 3/8 | .25 |
| 829-212C | 1-1/2x1-1/4 | 2-13/16 | 2-13/32 | 2-1/8 | 5/32 | .23 |
| 829-247C | 2x1/2 | 3-3/32 | 2-7/8 | 1-5/32 | 11/16 | .31 |
| 829-248C | 2x3/4 | 3-7/32 | 2-7/8 | 1-13/32 | 23/32 | .32 |
| 829-249C | 2x1 | 3-1/8 | 2-7/8 | 1-23/32 | 17/32 | .35 |
| 829-250C | 2x1-1/4 | 3-11/32 | 2-7/8 | 2-3/32 | 19/32 | .33 |
| 829-251C | 2x1-1/2 | 3-7/32 | 2-27/32 | 2-11/32 | 1/4 | .31 |
| 829-290C ¹ | 2-1/2x1-1/4 | 3-29/32 | 3-1/2 | 2-3/8 | 15/16 | .59 |
| 829-291C | 2-1/2x1-1/2 | 3-3/4 | 3-1/2 | 2-3/8 | 19/32 | .51 |

¹ Outlet sized with bushing





Pumping&Plumbing

Schedule 80 CPVC Technical Information
Schedule 80 CPVC Fittings

REDUCER COUPLING (continued)

Socket x Socket

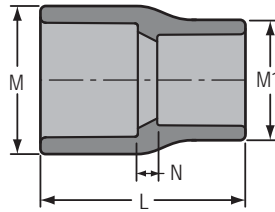

| Part Number | Size | L | M | M1 | N | Approx. Wt. (Lbs.) |
|-----------------------|---------|----------|----------|---------|----------|--------------------|
| 829-292C | 2-1/2x2 | 3-21/32 | 3-15/32 | 2-27/32 | 13/32 | .51 |
| 829-335C | 3x1 | 4-7/16 | 4-1/8 | 2-7/8 | 1-7/16 | 1.04 |
| 829-336C ¹ | 3x1-1/4 | 4-7/32 | 4-5/32 | 2-29/32 | 1-1/16 | .97 |
| 829-337C | 3x1-1/2 | 3-1/2 | 4-3/16 | 2-3/8 | 7/32 | .69 |
| 829-338C | 3x2 | 4 | 4-5/32 | 2-27/32 | 11/16 | .76 |
| 829-339C | 3x2-1/2 | 4-1/8 | 4-5/32 | 3-15/32 | 1/2 | .79 |
| 829-339CF | 3x2-1/2 | 6 | 4-1/16 | 3-7/16 | 1-3/4 | 1.01 |
| 829-416C ¹ | 4x3/4 | 5-23/32 | 5-9/32 | 2-29/32 | 2-13/32 | 1.78 |
| 829-417C ¹ | 4x1 | 5-15/16 | 5-9/32 | 2-29/32 | 2-17/32 | 1.54 |
| 829-419C ¹ | 4x1-1/2 | 5-23/32 | 5-9/32 | 2-29/32 | 2-1/16 | 1.68 |
| 829-420C | 4x2 | 5-1/2 | 5-9/32 | 2-7/8 | 1-25/32 | 1.50 |
| 829-421C | 4x2-1/2 | 4-9/16 | 5-3/16 | 3-1/2 | 17/32 | 1.35 |
| 829-422C | 4x3 | 4-19/32 | 5-1/4 | 4-3/16 | 15/32 | 1.33 |
| 829-488CF | 5x3 | 7-15/16 | 6-1/4 | 5-3/16 | 2-15/16 | 3.13 |
| 829-490CF | 5x4 | 7-3/4 | 6-1/4 | 5-3/16 | 2-1/2 | 2.53 |
| 829-528C ¹ | 6x2 | 7-1/16 | 7-1/2 | 5 | 2-9/16 | 4.42 |
| 829-529C | 6x2-1/2 | 6-31/32 | 7-19/32 | 5-9/32 | 2-3/16 | 4.72 |
| 829-530C ¹ | 6x3 | 7-1/8 | 7-9/16 | 5-9/32 | 2-1/4 | 4.25 |
| 829-530CF | 6x3 | 9-1/4 | 7-5/16 | 5-3/16 | 4-3/16 | 4.22 |
| 829-532C | 6x4 | 6-5/8 | 7-5/8 | 5-5/16 | 1-7/16 | 3.45 |
| 829-533CF | 6x5 | 8-15/16 | 7-3/8 | 6-5/16 | 2-11/16 | 3.93 |
| 829-580CF | 8x3 | 15 | 9-1/2 | 5-3/16 | 8-7/8 | 8.74 |
| 829-582C | 8x4 | 8-29/32 | 9-23/32 | 5-1/4 | 2-15/32 | 6.47 |
| 829-582CF | 8x4 | 14-5/8 | 9-1/2 | 5-3/16 | 8-1/8 | 9.36 |
| 829-583CF | 8x5 | 14-11/16 | 9-1/2 | 6-5/16 | 7-7/16 | 8.30 |
| 829-585C | 8x6 | 8 | 9-3/4 | 7-1/2 | 1 | 6.48 |
| 829-621CF | 10x2 | 21-1/2 | 11-3/4 | 5-3/16 | 14-3/4 | 17.05 |
| 829-623CF | 10x3 | 21-7/16 | 11-3/4 | 5-3/16 | 14-3/16 | 17.18 |
| 829-623CF | 10x3 | 21-1/2 | 11-3/4 | 5-3/16 | 14-7/16 | 20.10 |
| 829-624CF | 10x4 | 21-1/8 | 11-3/4 | 5-3/16 | 13-5/8 | 16.54 |
| 829-625CF | 10x5 | 21-3/16 | 11-3/4 | 6-5/16 | 12-15/16 | 16.94 |
| 829-626C | 10x6 | 10-19/32 | 12-1/32 | 7-19/32 | 2-17/32 | 11.43 |
| 829-626CF | 10x6 | 17-5/8 | 11-3/4 | 7-1/2 | 9-1/8 | 15.00 |
| 829-628C | 10x8 | 10-5/8 | 12 | 9-3/4 | 1-17/32 | 11.44 |
| 829-628CF | 10x8 | 13-3/8 | 11-3/4 | 9-5/8 | 3-7/8 | 12.00 |
| 829-664CF | 12x4 | 28-3/8 | 13-15/16 | 5-3/16 | 19-7/8 | 32.77 |
| 829-665CF | 12x5 | 28-7/16 | 13-15/16 | 6-5/16 | 19-3/16 | 33.24 |
| 829-666CF | 12x6 | 24-7/8 | 13-15/16 | 7-1/2 | 15-3/8 | 25.86 |
| 829-668C | 12x8 | 12-5/8 | 14-7/32 | 9-3/4 | 2-7/16 | 19.26 |

¹ Outlet sized with bushing



Schedule 80 CPVC Technical Information
Schedule 80 CPVC Fittings



Pumping&Plumbing

REDUCER COUPLING (continued)

Socket x Socket

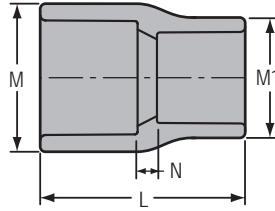

| Part Number | Size | L | M | M1 | N | Approx. Wt. (Lbs.) |
|-------------|-------|--------|----------|----------|--------|--------------------|
| 829-668CF | 12x8 | 20-5/8 | 13-15/16 | 9-5/8 | 10-1/8 | 24.34 |
| 829-670CF | 12x10 | 16-3/8 | 13-15/16 | 11-15/16 | 4-7/8 | 20.77 |
| 829-694CF | 14x4 | 30-1/8 | 15-3/16 | 5-3/16 | 20-7/8 | 32.89 |
| 829-696CF | 14x6 | 26-5/8 | 15-3/16 | 7-1/2 | 16-3/8 | 47.58 |
| 829-698CF | 14x8 | 22-3/8 | 15-3/16 | 9-5/8 | 11-1/8 | 27.69 |
| 829-700CF | 14x10 | 18-1/8 | 15-3/16 | 11-15/16 | 5-7/8 | 26.86 |
| 829-702CF | 14x12 | 17-3/4 | 15-3/8 | 14-1/8 | 4-1/2 | 29.14 |
| 829-754CF | 16x4 | 38 | 17-3/8 | 5-3/16 | 27-3/4 | 50.97 |
| 829-756CF | 16x6 | 34-1/2 | 17-3/8 | 7-1/2 | 23-1/4 | 61.20 |
| 829-758CF | 16x8 | 30-1/4 | 17-3/8 | 9-5/8 | 18 | 54.00 |
| 829-760CF | 16x10 | 26 | 17-3/8 | 11-15/16 | 12-3/4 | 51.35 |
| 829-762CF | 16x12 | 20-1/4 | 17-3/8 | 14-1/8 | 6 | 65.63 |
| 829-764CF | 16x14 | 21-1/4 | 17-1/2 | 15-1/2 | 5-1/4 | 50.00 |
| 829-784CF | 18x4 | 47-3/8 | 19-11/16 | 5-3/16 | 36-1/8 | 107.14 |
| 829-786CF | 18x6 | 43-7/8 | 19-11/16 | 7-1/2 | 31-5/8 | 105.76 |
| 829-788CF | 18x8 | 39-5/8 | 19-11/16 | 9-5/8 | 26-3/8 | 101.60 |
| 829-790CF | 18x10 | 35-3/8 | 19-11/16 | 11-15/16 | 21-1/8 | 89.54 |
| 829-792CF | 18x12 | 29-5/8 | 19-11/16 | 14-1/8 | 14-3/8 | 76.67 |
| 829-794CF | 18x14 | 29-5/8 | 19-11/16 | 15-1/2 | 13-5/8 | 87.00 |
| 829-796CF | 18x16 | 23 | 19-11/16 | 17-11/16 | 6 | 63.70 |
| 829-814CF | 20x4 | 58 | 21-7/8 | 5-3/16 | 45-3/4 | 159.76 |
| 829-816CF | 20x6 | 54-1/2 | 21-7/8 | 7-1/2 | 41-1/4 | 158.17 |
| 829-818CF | 20x8 | 50-1/4 | 21-7/8 | 9-5/8 | 36 | 154.50 |
| 829-820CF | 20x10 | 46 | 21-7/8 | 11-15/16 | 30-3/4 | 146.56 |
| 829-822CF | 20x12 | 40-1/4 | 21-7/8 | 14-1/8 | 24 | 137.46 |
| 829-824CF | 20x14 | 40-1/4 | 21-7/8 | 15-1/2 | 23-1/4 | --- |
| 829-826CF | 20x16 | 33-5/8 | 21-7/8 | 17-11/16 | 15-5/8 | 115.51 |
| 829-828CF | 20x18 | 25-1/2 | 21-7/8 | 19-7/8 | 6-1/2 | --- |
| 829-904CF | 24x4 | 71-1/2 | 26-1/16 | 5-3/16 | 57-1/4 | 241.69 |
| 829-906CF | 24x6 | 68 | 26-1/16 | 7-1/2 | 52-3/4 | 240.34 |
| 829-908CF | 24x8 | 63-3/4 | 26-1/16 | 9-5/8 | 47-1/2 | 236.18 |
| 829-910CF | 24x10 | 59-1/2 | 26-1/16 | 11-15/16 | 42-1/4 | 270.28 |
| 829-912CF | 24x12 | 53-3/4 | 26-1/16 | 14-1/8 | 35-1/2 | 219.13 |
| 829-914CF | 24x14 | 53-3/4 | 26-1/16 | 15-1/2 | 34-3/4 | --- |
| 829-916CF | 24x16 | 47-1/8 | 26-1/16 | 17-11/16 | 27-1/8 | 179.54 |
| 829-918CF | 24x18 | 39 | 26-1/16 | 19-7/8 | 18 | 167.74 |
| 829-920CF | 24x20 | 30-5/8 | 26-1/16 | 22-1/16 | 8-5/8 | 139.32 |





Pumping&Plumbing

Schedule 80 CPVC Technical Information
Schedule 80 CPVC Fittings

ECCENTRIC REDUCER COUPLING

Socket x Socket

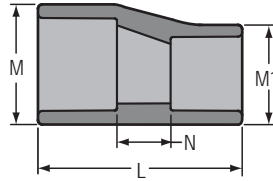

| Part Number | Size | L | M | M1 | N | Approx. Wt. (Lbs.) |
|-------------|-------------|---------|----------|---------|---------|--------------------|
| 829-101CFE | 3/4x1/2 | 3-3/8 | 1-3/8 | 1-1/8 | 1-5/8 | .09 |
| 829-130CFE | 1x1/2 | 3-1/2 | 1-5/8 | 1-1/8 | 1-1/2 | .11 |
| 829-131CFE | 1x3/4 | 4 | 1-5/8 | 1-3/8 | 1-3/4 | .15 |
| 829-168CFE | 1-1/4x1 | 5-1/8 | 2 | 1-11/16 | 2-3/8 | .30 |
| 829-209CFE | 1-1/2x1/2 | 7-1/8 | 2-1/4 | 1-1/8 | 4-7/8 | .33 |
| 829-210CFE | 1-1/2x3/4 | 7-5/8 | 2-1/4 | 1-3/8 | 5-1/8 | .34 |
| 829-211CFE | 1-1/2x1 | 5-3/8 | 2-1/4 | 1-11/16 | 2-5/8 | .35 |
| 829-212CFE | 1-1/2x1-1/4 | 4-9/16 | 2-5/16 | 2-1/16 | 1-9/16 | .33 |
| 829-249CFE | 2x1 | 6-1/8 | 2-3/4 | 1-11/16 | 3-1/8 | .37 |
| 829-250CFE | 2x1-1/4 | 6-1/8 | 2-3/4 | 2-1/16 | 2-7/8 | .46 |
| 829-251CFE | 2x1-1/2 | 6 | 2-3/4 | 2-5/16 | 2-3/4 | .47 |
| 829-289CFE | 2-1/2x1 | 10-5/8 | 3-5/16 | 1-11/16 | 7-3/8 | .90 |
| 829-290CFE | 2-1/2x1-1/4 | 10-5/8 | 3-5/16 | 2-1/16 | 7-1/8 | 1.15 |
| 829-291CFE | 2-1/2x1-1/2 | 10-1/2 | 3-5/16 | 2-5/16 | 7 | 1.24 |
| 829-292CFE | 2-1/2x2 | 6-7/8 | 3-5/16 | 2-13/16 | 3-1/8 | .86 |
| 829-335CFE | 3x1 | 11-7/8 | 3-15/16 | 1-11/16 | 8-3/8 | 1.58 |
| 829-336CFE | 3x1-1/4 | 11-7/8 | 3-15/16 | 2-1/16 | 8-1/8 | 1.27 |
| 829-337CFE | 3x1-1/2 | 11-3/4 | 3-15/16 | 2-5/16 | 8 | 1.41 |
| 829-338CFE | 3x2 | 5-7/8 | 4-5/32 | 2-7/8 | 2-15/32 | 1.07 |
| 829-339CFE | 3x2-1/2 | 7-1/4 | 4-1/16 | 3-7/16 | 3 | 1.26 |
| 829-417CFE | 4x1 | 17 | 5-1/8 | 1-11/16 | 13-1/2 | 3.48 |
| 829-418CFE | 4x1-1/4 | 17 | 5-1/8 | 2-1/16 | 13-1/4 | 3.00 |
| 829-419CFE | 4x1-1/2 | 16-7/8 | 5-1/8 | 2-5/16 | 13-1/8 | 2.60 |
| 829-420CFE | 4x2 | 13-1/4 | 5-1/8 | 2-13/16 | 9-1/4 | 2.47 |
| 829-421CFE | 4x2-1/2 | 12-3/8 | 5-1/8 | 3-7/16 | 8-1/8 | 2.58 |
| 829-422CFE | 4x3 | 8-3/4 | 5-1/8 | 4-1/8 | 4-1/4 | 2.04 |
| 829-528CFE | 6x2 | 20-7/8 | 7-5/16 | 2-13/16 | 15-7/8 | 7.02 |
| 829-529CFE | 6x2-1/2 | 20 | 7-5/16 | 3-7/16 | 14-3/4 | 7.48 |
| 829-530CFE | 6x3 | 16-3/8 | 7-5/16 | 4-1/8 | 10-7/8 | 6.16 |
| 829-532CFE | 6x4 | 11-1/8 | 7-5/16 | 5-3/16 | 5-5/8 | 4.43 |
| 829-533CFE | 6x5 | 11-1/4 | 7-3/8 | 6-5/16 | 5 | 6.44 |
| 829-578CFE | 8x2 | 30-5/8 | 9-1/2 | 2-13/16 | 24-5/8 | 17.32 |
| 829-580CFE | 8x3 | 26-1/8 | 9-1/2 | 4-1/8 | 19-5/8 | 16.42 |
| 829-582CFE | 8x4 | 20-7/8 | 9-1/2 | 5-3/16 | 14-3/8 | 13.59 |
| 829-583CFE | 8x5 | 21 | 9-1/2 | 6-5/16 | 13-3/4 | 11.81 |
| 829-585CFE | 8x6 | 15-1/4 | 9-1/2 | 7-1/2 | 7-3/4 | 9.78 |
| 829-624CFE | 10x4 | 32 | 11-3/4 | 5-3/16 | 24-1/2 | 29.89 |
| 829-625CFE | 10x5 | 32-1/8 | 11-3/4 | 6-5/16 | 23-7/8 | 27.68 |
| 829-626CFE | 10x6 | 26-3/8 | 11-3/4 | 7-1/2 | 17-7/8 | 25.59 |
| 829-628CFE | 10x8 | 18-1/16 | 11-3/4 | 9-5/8 | 8-9/16 | 17.28 |
| 829-664CFE | 12x4 | 43-1/2 | 13-15/16 | 5-3/16 | 35 | 56.73 |



Schedule 80 CPVC Technical Information
Schedule 80 CPVC Fittings



Pumping&Plumbing

ECCENTRIC REDUCER COUPLING (continued)

Socket x Socket

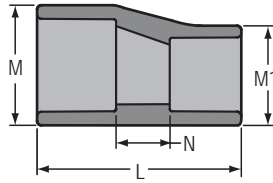

| Part Number | Size | L | M | M1 | N | Approx. Wt. (Lbs.) |
|-------------|-------|----------|----------|----------|----------|--------------------|
| 829-665CFE | 12x5 | 43-5/8 | 13-15/16 | 6-5/16 | 34-3/8 | 42.50 |
| 829-666CFE | 12x6 | 37-7/8 | 13-15/16 | 7-1/2 | 28-3/8 | 52.43 |
| 829-668CFE | 12x8 | 29-9/16 | 13-15/16 | 9-5/8 | 19-1/16 | 34.80 |
| 829-670CFE | 12x10 | 20-5/8 | 13-15/16 | 11-15/16 | 9-1/8 | 26.06 |
| 829-696CFE | 14x6 | 41-3/8 | 15-3/16 | 7-1/2 | 31-1/8 | 67.95 |
| 829-698CFE | 14x8 | 33-1/16 | 15-3/16 | 9-5/8 | 21-13/16 | 39.32 |
| 829-700CFE | 14x10 | 24-1/8 | 15-3/16 | 11-15/16 | 11-7/8 | 60.41 |
| 829-702CFE | 14x12 | 20-1/8 | 15-3/8 | 14-1/8 | 6-7/8 | 41.52 |
| 829-756CFE | 16x6 | 54-1/4 | 17-1/2 | 7-1/2 | 43 | 96.99 |
| 829-758CFE | 16x8 | 45-15/16 | 17-1/2 | 9-5/8 | 33-11/16 | 91.61 |
| 829-760CFE | 16x10 | 37 | 17-1/2 | 11-15/16 | 23-3/4 | 85.11 |
| 829-762CFE | 16x12 | 33 | 17-1/2 | 14-1/8 | 18-3/4 | 71.78 |
| 829-764CFE | 16x14 | 24-5/8 | 17-1/2 | 15-1/2 | 9-5/8 | 59.26 |
| 829-786CFE | 18x6 | 69-1/4 | 19-11/16 | 7-1/2 | 57 | 164.92 |
| 829-788CFE | 18x8 | 60-15/16 | 19-11/16 | 9-5/8 | 47-11/16 | 152.22 |
| 829-790CFE | 18x10 | 52 | 19-11/16 | 11-15/16 | 37-3/4 | 148.37 |
| 829-792CFE | 18x12 | 48 | 19-11/16 | 14-1/8 | 32-3/4 | 132.56 |
| 829-794CFE | 18x14 | 39-5/8 | 19-11/16 | 15-1/2 | 23-5/8 | 111.06 |
| 829-796CFE | 18x16 | 28-5/8 | 19-11/16 | 17-11/16 | 11-5/8 | 85.64 |



FABRICATED REPAIR COUPLING

Gasket x Gasket

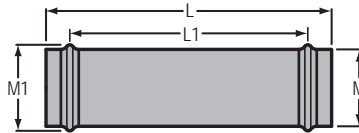

| Part Number | Size | L | L1 | M | M1 | Approx. Wt. (Lbs.) |
|-------------|------|--------|----------|----------|--------|--------------------|
| 828-020CF | 2 | 9-1/8 | 11-3/4 | 4-1/8 | 4-5/8 | .97 |
| 828-030CF | 3 | 15-1/2 | 11-3/4 | 4-1/8 | 4-5/8 | 3.39 |
| 828-040CF | 4 | 19-1/2 | 15 | 5-3/16 | 5-3/4 | 6.54 |
| 828-060CF | 6 | 23 | 16 | 7-1/2 | 8-1/8 | 13.41 |
| 828-080CF | 8 | 26-5/8 | 19-11/16 | 9-5/8 | 10-3/8 | 21.45 |
| 828-100CF | 10 | 28 | 21-1/4 | 10-3/4 | 12-1/4 | --- |
| 828-120CF | 12 | 30 | 22-1/2 | 14-1/8 | 16-1/8 | --- |
| 828-140CF | 14 | 19 | 11-1/2 | 15-1/2 | 16-3/8 | 45.50 |
| 828-160CF | 16 | 21-5/8 | 12-3/8 | 17-11/16 | 18-3/4 | 60.00 |



Pumping&Plumbing

Schedule 80 CPVC Technical Information
Schedule 80 CPVC Fittings

COUPLING

Fipt x Fipt

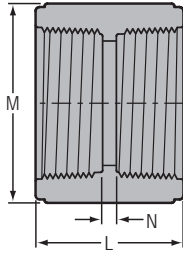

| Part Number | Size | L | M | N | Approx. Wt. (Lbs.) |
|-------------|-------|---------|---------|--------|--------------------|
| 830-002C | 1/4 | 1-11/32 | 13/16 | 5/32 | .02 |
| 830-003C | 3/8 | 1-15/32 | 1 | 9/32 | .04 |
| 830-005C | 1/2 | 1-5/8 | 1-9/32 | 1/4 | .07 |
| 830-007C | 3/4 | 1-11/16 | 1-5/8 | 3/32 | .09 |
| 830-010C | 1 | 2-3/32 | 1-15/16 | 1/8 | .15 |
| 830-012C | 1-1/4 | 2-3/16 | 2-9/32 | 3/16 | .22 |
| 830-015C | 1-1/2 | 2-7/32 | 2-5/8 | 3/16 | .30 |
| 830-020C | 2 | 2-7/32 | 3 | 7/32 | .35 |
| 830-025C | 2-1/2 | 3-5/16 | 3-9/16 | 1/8 | .71 |
| 830-030C | 3 | 3-15/32 | 4-3/8 | 21/32 | 1.13 |
| 830-040C | 4 | 3-21/32 | 5-9/16 | 3/16 | 1.61 |
| 830-060CF | 6 | 3-3/4 | 7-3/16 | 3/4 | 1.76 |
| 830-080CF | 8 | 4-1/2 | 9-3/8 | 1-1/16 | 3.33 |

SPECIAL REINFORCED COUPLING

SR Fipt x SR Fipt

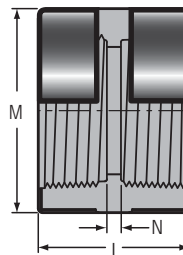

| Part Number | Size | L | M | N | Approx. Wt. (Lbs.) |
|-------------|-------|---------|---------|-------|--------------------|
| 830-005CSR | 1/2 | 1-19/32 | 1-7/32 | 9/32 | .06 |
| 830-007CSR | 3/4 | 1-5/8 | 1-3/8 | 1/8 | .07 |
| 830-010CSR | 1 | 1-15/16 | 1-23/32 | 1/16 | .13 |
| 830-012CSR | 1-1/4 | 2-1/16 | 2-1/16 | 5/16 | .17 |
| 830-015CSR | 1-1/2 | 2-5/32 | 2-7/16 | 11/32 | .25 |
| 830-020CSR | 2 | 2-1/4 | 3-1/32 | 1/4 | .39 |

Schedule 80 CPVC Technical Information
Schedule 80 CPVC Fittings



Pumping&Plumbing

REDUCER COUPLING

Fipt x Fipt

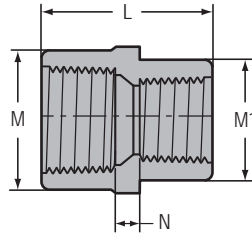

| Part Number | Size | L | M | M1 | N | Approx. Wt. (Lbs.) |
|-----------------------|---------|---------|--------|--------|-------|--------------------|
| 830-072C ¹ | 1/2x1/4 | 1-31/32 | 1-5/16 | 1-5/32 | 5/8 | .08 |
| 830-073C ¹ | 1/2x3/8 | 1-29/32 | 1-7/32 | 1-7/32 | 19/32 | .08 |
| 830-101C | 3/4x1/2 | 1-23/32 | 1-3/8 | 1-7/32 | 7/32 | .08 |

¹ Outlet sized with bushing

SPECIAL REINFORCED REDUCER COUPLING

SR Fipt x SR Fipt

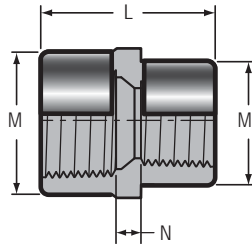

| Part Number | Size | L | M | M1 | N | Approx. Wt. (Lbs.) |
|-------------|-------------|---------|---------|---------|---------|--------------------|
| 830-101CSR | 3/4x1/2 | 1-23/32 | 1-3/8 | 1-7/32 | 7/32 | .09 |
| 830-130CSR | 1x1/2 | 2-1/4 | 1-23/32 | 1-7/32 | 21/32 | .17 |
| 830-131CSR | 1x3/4 | 2-13/32 | 1-23/32 | 1-3/8 | 23/32 | .17 |
| 830-210CSR | 1-1/2x3/4 | 2-7/8 | 2-7/16 | 1-3/8 | 1-7/32 | .29 |
| 830-211CSR | 1-1/2x1 | 2-15/16 | 2-7/16 | 1-11/16 | 7/16 | .36 |
| 830-212CSR | 1-1/2x1-1/4 | 2-7/8 | 2-1/2 | 2-3/32 | 15/16 | .34 |
| 830-249CSR | 2x1 | 3-3/16 | 3 | 1-23/32 | 1-17/32 | .48 |
| 830-251CSR | 2x1-1/2 | 3-1/4 | 3 | 2-7/16 | 1-7/16 | .52 |



GROOVED COUPLING ADAPTER

Groove x Socket

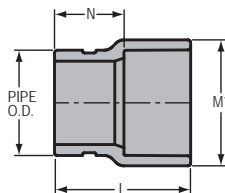

| Part Number | Size | L | M1 | N | Approx. Wt. (Lbs.) |
|-------------|-------|---------|---------|---------|--------------------|
| 833-012C | 1-1/4 | 2-13/16 | 2-1/16 | 1-9/16 | .17 |
| 833-015C | 1-1/2 | 2-29/32 | 2-11/32 | 1-1/2 | .20 |
| 833-020C | 2 | 3-1/16 | 2-7/8 | 1-9/16 | .30 |
| 833-025C | 2-1/2 | 3-3/8 | 3-1/2 | 1-5/8 | .52 |
| 833-030C | 3 | 3-9/16 | 4-3/16 | 1-11/16 | .72 |



Pumping&Plumbing

Schedule 80 CPVC Technical Information
Schedule 80 CPVC Fittings

GROOVED COUPLING ADAPTER

Groove x Socket

(continued)

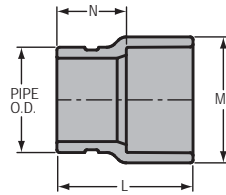

| Part Number PVC | Size | L | M1 | N | Approx. Wt. (Lbs.) |
|--------------------|------|---------|----------|---------|--------------------|
| | | | | | PVC |
| 833-040C | 4 | 4-17/32 | 5-1/4 | 2-9/32 | 1.38 |
| 833-050CF | 5 | 7 | 6-5/16 | 4 | 2.35 |
| 833-060C | 6 | 5-5/16 | 7-9/16 | 2-5/16 | 3.00 |
| 833-080CF | 8 | 8-3/16 | 9-5/8 | 3-15/16 | 7.16 |
| 833-100CF | 10 | 9-7/8 | 11-15/16 | 4-5/8 | 10.72 |
| 833-120CF | 12 | 10-7/8 | 14-1/8 | 4-5/8 | 24.11 |



FEMALE ADAPTER

Socket x Fipt

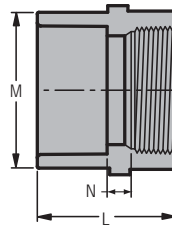

| Part Number | Size | L | M | N | Approx. Wt. (Lbs.) |
|-------------|-------|---------|----------|--------|--------------------|
| 835-002C | 1/4 | 1-11/32 | 27/32 | 3/32 | .02 |
| 835-003C | 3/8 | 1-15/32 | 1 | 3/32 | .04 |
| 835-005C | 1/2 | 1-3/4 | 1-5/32 | 3/32 | .06 |
| 835-007C | 3/4 | 1-27/32 | 1-13/32 | 3/32 | .08 |
| 835-010C | 1 | 2-1/8 | 1-23/32 | 3/32 | .14 |
| 835-012C | 1-1/4 | 2-5/16 | 2-3/32 | 3/32 | .22 |
| 835-015C | 1-1/2 | 2-1/2 | 2-11/32 | 3/32 | .21 |
| 835-020C | 2 | 3 | 3-1/32 | 1/4 | .42 |
| 835-025C | 2-1/2 | 3-1/4 | 3-9/16 | 7/32 | .67 |
| 835-030C | 3 | 3-15/32 | 4-1/4 | 3/16 | .76 |
| 835-040C | 4 | 3-31/32 | 5-7/32 | 1/4 | 1.71 |
| 835-060C | 6 | 4-31/32 | 7-21/32 | 5/16 | 3.22 |
| 835-080C | 8 | 6-5/32 | 9-23/32 | 1/4 | 5.39 |
| 835-080CF | 8 | 8-9/16 | 9-5/8 | 2-9/16 | 6.56 |
| 835-100CF | 10 | 10-1/4 | 11-15/16 | 3 | 11.59 |
| 835-120CF | 12 | 11-1/8 | 14-1/8 | 2-5/8 | 20.00 |

Schedule 80 CPVC Technical Information
Schedule 80 CPVC Fittings



Pumping&Plumbing

SPECIAL REINFORCED FEMALE ADAPTER

Socket x SR Fipt

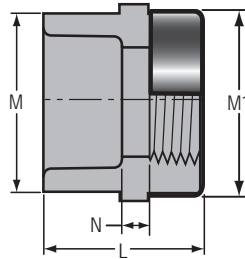

| Part Number | Size | L | M | M1 | N | Approx. Wt. (Lbs.) |
|-------------|-------|---------|---------|---------|-------|--------------------|
| 835-002CSR | 1/4 | 1-13/32 | 27/32 | 27/32 | 3/32 | .03 |
| 835-003CSR | 3/8 | 1-15/32 | 15/16 | 31/32 | 3/32 | .04 |
| 835-005CSR | 1/2 | 1-3/4 | 1-5/32 | 1-3/16 | 3/16 | .07 |
| 835-007CSR | 3/4 | 1-7/8 | 1-13/32 | 1-3/8 | 3/32 | .09 |
| 835-010CSR | 1 | 2-1/8 | 1-11/16 | 1-23/32 | 3/32 | .14 |
| 835-012CSR | 1-1/4 | 2-5/16 | 2-3/32 | 2-1/16 | 3/32 | .20 |
| 835-015CSR | 1-1/2 | 2-7/16 | 2-13/32 | 2-7/16 | 7/32 | .28 |
| 835-020CSR | 2 | 2-23/32 | 3 | 3-1/32 | 1/4 | .45 |
| 835-025CSR | 2-1/2 | 3-1/4 | 3-9/16 | 3-9/16 | 11/32 | .70 |
| 835-030CSR | 3 | 3-1/2 | 4-1/4 | 4-9/32 | 7/32 | 1.01 |
| 835-040CSR | 4 | 3-31/32 | 5-7/32 | 5-1/4 | 7/32 | 1.35 |
| 835-060CSR | 6 | 4-31/32 | 7-5/8 | 7-21/32 | 1/4 | 3.25 |



REDUCING FEMALE ADAPTER

Socket x SR Fipt

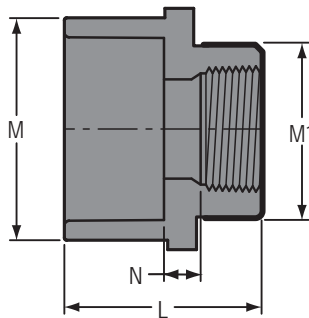

| Part Number | Size | L | M | M1 | N | Approx. Wt. (Lbs.) |
|-------------|---------|---------|---------|-------|-----|--------------------|
| 835-098C | 3/4x1/4 | 1-15/16 | 1-13/32 | 27/32 | --- | .06 |



Pumping&Plumbing

Schedule 80 CPVC Technical Information
Schedule 80 CPVC Fittings

**SPECIAL REINFORCED
 REDUCING FEMALE ADAPTER**

Socket x SR Fipt

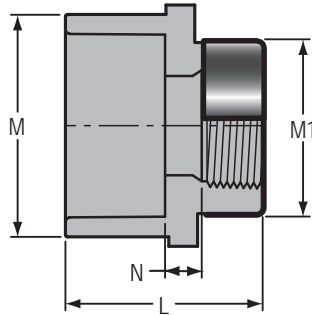

| Part Number | Size | L | M | M1 | N | Approx. Wt. (Lbs.) |
|-------------|---------|---------|---------|---------|-------|--------------------|
| 835-074CSR | 1/2x3/4 | 1-3/4 | 1-3/16 | 1-3/8 | 7/32 | .08 |
| 835-098CSR | 3/4x1/4 | 1-15/16 | 1-13/32 | 27/32 | 13/32 | .07 |
| 835-101CSR | 3/4x1/2 | 1-7/8 | 1-3/8 | 1-3/16 | 3/16 | .08 |
| 835-102CSR | 3/4x1 | 2-1/16 | 1-7/16 | 1-11/16 | 7/32 | .13 |
| 835-130CSR | 1x1/2 | 2 | 1-11/16 | 1-3/16 | 7/32 | .11 |
| 835-131CSR | 1x3/4 | 2-3/32 | 1-3/4 | 1-3/8 | 1/4 | .13 |

TRANSITION FEMALE ADAPTER

Socket x Brass Fipt

Dimensions Also Applicable to 835-XXXSS

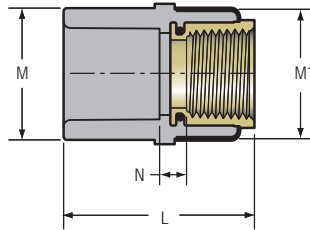

| Part Number | Size | L | M | M1 | N | Approx. Wt. (Lbs.) |
|-------------|-------|---------|---------|---------|-------|--------------------|
| 835-005CBR | 1/2 | 1-25/32 | 1-5/32 | 1-7/32 | 5/8 | .12 |
| 835-007CBR | 3/4 | 2 | 1-13/32 | 1-3/8 | 3/8 | .24 |
| 835-010CBR | 1 | 2-7/32 | 1-3/4 | 1-11/16 | 13/32 | .31 |
| 835-012CBR | 1-1/4 | 2-3/8 | 2-3/32 | 2-1/16 | 3/8 | .36 |
| 835-015CBR | 1-1/2 | 2-17/32 | 2-13/32 | 2-7/16 | 13/32 | .48 |
| 835-020CBR | 2 | 2-25/32 | 2-7/8 | 3-3/16 | 7/16 | 1.05 |

Not intended to convey or dispense water for human consumption through drinking or cooking

**TRANSITION REDUCING
 FEMALE ADAPTER**

Socket x Brass Fipt

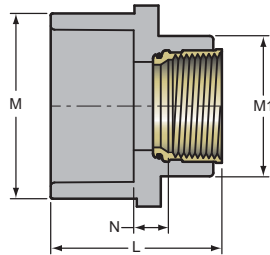

| Part Number | Size | L | M | M1 | N | Approx. Wt. (Lbs.) |
|-------------|---------|--------|--------|--------|-------|--------------------|
| 835-101CBR | 3/4x1/2 | 2-1/32 | 1-7/16 | 1-3/16 | 15/32 | .18 |

Not intended to convey or dispense water for human consumption through drinking or cooking

Schedule 80 CPVC Technical Information
Schedule 80 CPVC Fittings



Pumping&Plumbing

ENCAPSULATED SPECIAL REINFORCED FEMALE ADAPTER

Socket x ESR Fipt

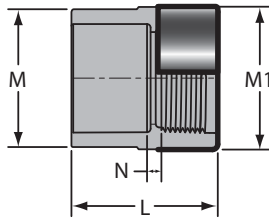

| Part Number | Size | L | M | M1 | N | Approx. Wt. (Lbs.) |
|-------------|-------|---------|---------|---------|-------|--------------------|
| 835-002CESR | 1/4 | 1-1/2 | 27/32 | 29/32 | 3/32 | .05 |
| 835-003CESR | 3/8 | 1-17/32 | 15/16 | 1-1/32 | 3/16 | .04 |
| 835-005CESR | 1/2 | 1-7/8 | 1-3/16 | 1-9/32 | 9/32 | .07 |
| 835-007CESR | 3/4 | 2 | 1-13/32 | 1-15/32 | 1/8 | .11 |
| 835-010CESR | 1 | 2-1/4 | 1-3/4 | 1-13/16 | 1/8 | .15 |
| 835-012CESR | 1-1/4 | 2-7/16 | 2-1/8 | 2-5/32 | 3/16 | .22 |
| 835-015CESR | 1-1/2 | 2-9/16 | 2-13/32 | 2-1/2 | 1/4 | .31 |
| 835-020CESR | 2 | 2-27/32 | 3 | 3-3/32 | 13/32 | .49 |

MALE ADAPTER

Spigot x Mipt

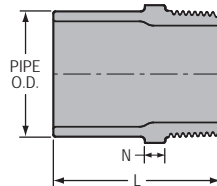

| Part Number | Size | L | N | Approx. Wt. (Lbs.) |
|-------------|-------|---------|-------|--------------------|
| 861-005C | 1/2 | 1-13/16 | 5/16 | .03 |
| 861-007C | 3/4 | 1-31/32 | 5/16 | .05 |
| 861-010C | 1 | 2-3/32 | 1/4 | .08 |
| 861-131C | 1x3/4 | 2 | 1/4 | .07 |
| 861-012C | 1-1/4 | 2-9/32 | 9/32 | .13 |
| 861-015C | 1-1/2 | 2-5/8 | 11/32 | .15 |
| 861-020C | 2 | 2-13/16 | 13/32 | .24 |



SPECIAL REINFORCED SPIGOT FEMALE ADAPTER

Spigot x SR Fipt

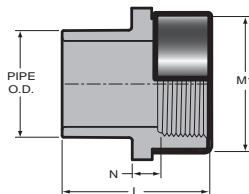

| Part Number | Size | L | M1 | N | Approx. Wt. (Lbs.) |
|-------------|-------|---------|---------|-------|--------------------|
| 878-005CSR | 1/2 | 1-3/4 | 1-3/16 | 5/32 | .06 |
| 878-007CSR | 3/4 | 1-15/16 | 1-3/8 | 3/16 | .08 |
| 878-010CSR | 1 | 2-1/4 | 1-11/16 | 7/32 | .13 |
| 878-012CSR | 1-1/4 | 2-15/32 | 2-1/16 | 1/4 | .19 |
| 878-015CSR | 1-1/2 | 2-21/32 | 2-7/16 | 13/32 | .26 |



Pumping&Plumbing

Schedule 80 CPVC Technical Information
Schedule 80 CPVC Fittings

**SPECIAL REINFORCED SPIGOT
 FEMALE ADAPTER (continued)**

Spigot x SR Fipt

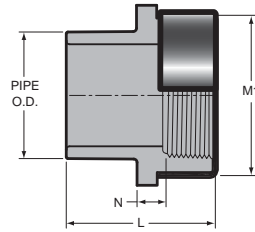

| Part Number | Size | L | M1 | N | Approx. Wt. (Lbs.) |
|-------------|------|---------|--------|-------|--------------------|
| 878-020CSR | 2 | 2-13/16 | 3 | 3/8 | .40 |
| 878-030CSR | 3 | 3-27/32 | 4-9/32 | 17/32 | .97 |
| 878-040CSR | 4 | 4-3/8 | 5-1/4 | 5/8 | 1.42 |

**SPECIAL REINFORCED REDUCING
 SPIGOT FEMALE ADAPTER**

Spigot x SR Fipt

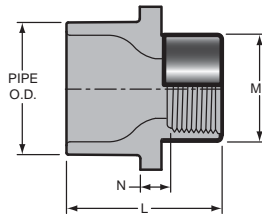

| Part Number | Size | L | M1 | N | Approx. Wt. (Lbs.) |
|-------------|---------|---------|-------|-------|--------------------|
| 878-072CSR | 1/2x1/4 | 1-13/32 | 27/32 | 3/16 | .03 |
| 878-098CSR | 3/4x1/4 | 1-27/32 | 27/32 | 7/32 | .06 |
| 878-128CSR | 1x1/4 | 2-3/8 | 27/32 | 21/32 | .09 |

**ENCAPSULATED SPECIAL REINFORCED
 SPIGOT FEMALE ADAPTER**

Spigot x ESR Fipt

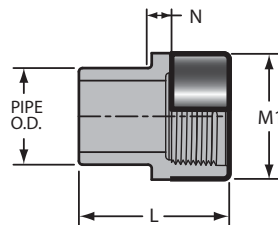

| Part Number | Size | L | M1 | N | Approx. Wt. (Lbs.) |
|-------------|-------|---------|---------|-------|--------------------|
| 878-005CESR | 1/2 | 1-7/8 | 1-9/32 | 3/16 | .07 |
| 878-007CESR | 3/4 | 2-1/16 | 1-15/32 | 3/8 | .09 |
| 878-010CESR | 1 | 2-3/8 | 1-25/32 | 11/32 | .15 |
| 878-012CESR | 1-1/4 | 2-19/32 | 2-5/32 | 5/16 | .20 |
| 878-015CESR | 1-1/2 | 2-3/4 | 2-1/2 | 13/32 | .29 |
| 878-020CESR | 2 | 2-15/16 | 3-3/32 | 5/16 | .44 |

Schedule 80 CPVC Technical Information
Schedule 80 CPVC Fittings



Pumping&Plumbing

TRANSITION FEMALE ADAPTER

Spigot x Brass Fipt

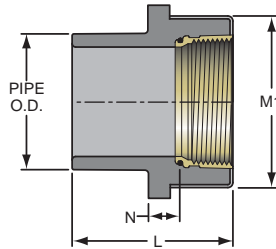

| Part Number | Size | L | M1 | N | Approx. Wt. (Lbs.) |
|-------------|------|--------|---------|-------|--------------------|
| 878-010CBR | 1 | 2-9/32 | 1-23/32 | 13/32 | .23 |

Not intended to convey or dispense water for human consumption through drinking or cooking

MALE ADAPTER

Mipt x Socket

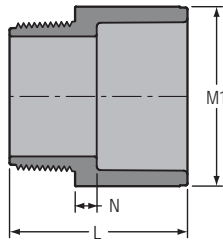

| Part Number | Size | L | M1 | N | Approx. Wt. (Lbs.) |
|-------------|-------|---------|----------|--------|--------------------|
| 836-005C | 1/2 | 1-23/32 | 1-5/32 | 3/16 | .05 |
| 836-007C | 3/4 | 1-27/32 | 1-7/16 | 7/32 | .06 |
| 836-010C | 1 | 2-5/32 | 1-23/32 | 7/32 | .10 |
| 836-012C | 1-1/4 | 2-1/4 | 2-1/8 | 1/32 | .16 |
| 836-015C | 1-1/2 | 2-9/16 | 2-13/32 | 9/32 | .19 |
| 836-020C | 2 | 2-7/8 | 2-7/8 | 5/16 | .31 |
| 836-025C | 2-1/2 | 3-21/32 | 3-17/32 | 11/32 | .54 |
| 836-030C | 3 | 3-7/8 | 4-1/4 | 3/8 | .78 |
| 836-040C | 4 | 4-13/32 | 5-5/16 | 13/32 | 1.18 |
| 836-050CF | 5 | 6 | 6-5/16 | 1-5/8 | 2.22 |
| 836-060C | 6 | 5-1/2 | 7-9/16 | 19/32 | 3.04 |
| 836-080CF | 8 | 8-3/16 | 9-5/8 | 2-3/16 | 5.95 |
| 836-100CF | 10 | 10-3/8 | 11-15/16 | 3-3/16 | 10.95 |
| 836-120CF | 12 | 11-1/8 | 14-1/8 | 2-3/4 | 19.99 |





Pumping&Plumbing

Schedule 80 CPVC Technical Information
Schedule 80 CPVC Fittings

REDUCING MALE ADAPTER

Mipt x Socket

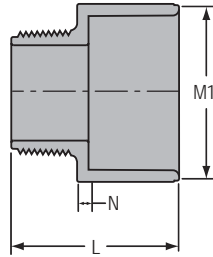

| Part Number | Size | L | M1 | N | Approx. Wt. (Lbs.) |
|-------------|-------|--------|---------|-------|--------------------|
| 836-102C | 3/4x1 | 2-9/32 | 1-3/4 | 17/32 | .10 |
| 836-131C | 1x3/4 | 2-1/16 | 1-13/32 | 1/4 | .07 |

REINFORCED MALE ADAPTER

Rmipt x Socket

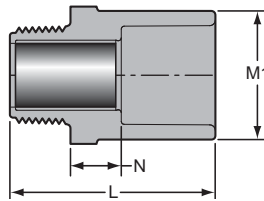

| Part Number | Size | L | M1 | N | Approx. Wt. (Lbs.) |
|-------------|------|---------|---------|-------|--------------------|
| 836-005CR | 1/2 | 2-3/32 | 1-5/32 | 9/16 | .06 |
| 836-007CR | 3/4 | 2-1/4 | 1-3/8 | 9/16 | .09 |
| 836-010CR | 1 | 2-21/32 | 1-23/32 | 11/16 | .15 |

TRANSITION MALE ADAPTER

Brass Mipt x Socket

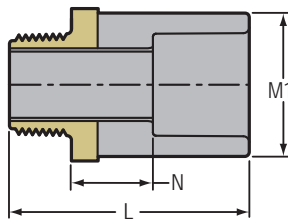

| Part Number | Size | L | M1 | N | Approx. Wt. (Lbs.) |
|-------------|-------|---------|---------|-------|--------------------|
| 836-005CBR | 1/2 | 2-13/32 | 1-9/32 | 27/32 | .20 |
| 836-007CBR | 3/4 | 2-17/32 | 1-13/32 | 13/16 | .26 |
| 836-010CBR | 1 | 2-15/16 | 1-23/32 | 29/32 | .43 |
| 836-012CBR | 1-1/4 | 3-1/8 | 2-3/32 | 31/32 | .66 |
| 836-015CBR | 1-1/2 | 3-9/32 | 2-11/32 | 1 | .80 |
| 836-020CBR | 2 | 3-7/16 | 2-27/32 | 31/32 | 1.01 |

Schedule 80 CPVC Technical Information
Schedule 80 CPVC Fittings



Pumping&Plumbing

REDUCER BUSHING

Flush Style

Spigot x Socket

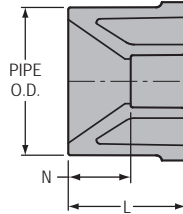

| Part Number | Size | L | N | Approx. Wt. (Lbs.) |
|-----------------------|-------------|---------|---------|--------------------|
| 837-052C | 3/8x1/4 | 31/32 | 5/16 | .01 |
| 837-072C | 1/2x1/4 | 1-3/32 | 13/32 | .02 |
| 837-073C | 1/2x3/8 | 1-1/8 | 11/32 | .02 |
| 837-101C | 3/4x1/2 | 1-7/32 | 11/32 | .03 |
| 837-129C ¹ | 1x3/8 | 1-5/8 | 27/32 | .10 |
| 837-130C | 1x1/2 | 1-11/32 | 11/32 | .07 |
| 837-131C | 1x3/4 | 1-11/32 | 5/16 | .04 |
| 837-166C | 1-1/4x1/2 | 1-1/2 | 5/8 | .12 |
| 837-167C | 1-1/4x3/4 | 1-1/2 | 1/2 | .10 |
| 837-168C | 1-1/4x1 | 1-19/32 | 15/32 | .09 |
| 837-209C | 1-1/2x1/2 | 1-23/32 | 13/16 | .15 |
| 837-210C | 1-1/2x3/4 | 1-5/8 | 5/8 | .16 |
| 837-211C | 1-1/2x1 | 1-9/16 | 13/32 | .13 |
| 837-212C | 1-1/2x1-1/4 | 1-9/16 | 9/32 | .07 |
| 837-247C | 2x1/2 | 1-29/32 | 1 | .30 |
| 837-248C | 2x3/4 | 1-29/32 | 21/32 | .23 |
| 837-249C | 2x1 | 1-25/32 | 5/8 | .25 |
| 837-250C | 2x1-1/4 | 1-11/16 | 7/16 | .23 |
| 837-251C | 2x1-1/2 | 1-3/4 | 11/32 | .16 |
| 837-289C | 2-1/2x1 | 2-1/32 | 29/32 | .39 |
| 837-290C | 2-1/2x1-1/4 | 2-5/32 | 13/32 | .41 |
| 837-291C | 2-1/2x1-1/2 | 2-5/32 | 3/4 | .40 |
| 837-292C | 2-1/2x2 | 2-1/16 | 17/32 | .30 |
| 837-334C ¹ | 3x3/4 | 2-9/16 | 1-17/32 | .74 |
| 837-335C | 3x1 | 2-9/32 | 1-1/8 | .70 |
| 837-336C | 3x1-1/4 | 2-1/4 | 1 | .70 |
| 837-337C | 3x1-1/2 | 2-9/32 | 7/8 | .67 |
| 837-338C | 3x2 | 2-7/32 | 23/32 | .64 |
| 837-339C | 3x2-1/2 | 2-5/16 | 1/4 | .43 |
| 837-416C ¹ | 4x3/4 | 2-27/32 | 1-27/32 | 1.37 |
| 837-418C ¹ | 4x1-1/4 | 3-9/16 | 1-11/16 | 1.38 |
| 837-420C | 4x2 | 2-21/32 | 1-1/8 | 1.13 |

¹ Outlet sized with bushing





Pumping&Plumbing

Schedule 80 CPVC Technical Information
Schedule 80 CPVC Fittings

REDUCER BUSHING (continued)

Flush Style

Spigot x Socket

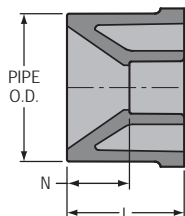

| Part Number | Size | L | N | Approx. Wt. (Lbs.) |
|-----------------------|---------|---------|---------|--------------------|
| 837-422C | 4x3 | 2-9/16 | 11/16 | .86 |
| 837-490C | 5x4 | 2-31/32 | 23/32 | --- |
| 837-490CF | 5x4 | 3 | 3/4 | 1.50 |
| 837-525C ¹ | 6x1 | 3-31/32 | 2-13/16 | 3.28 |
| 837-527C ¹ | 6x1-1/2 | 3-3/4 | 2-11/32 | 3.02 |
| 837-528C | 6x2 | 3-17/32 | 2-1/32 | 3.00 |
| 837-529C ¹ | 6x2-1/2 | 3-29/32 | 2-5/32 | 3.45 |
| 837-530C | 6x3 | 3-17/32 | 2-1/8 | 3.05 |
| 837-532C | 6x4 | 3-9/16 | 1-1/4 | 2.95 |
| 837-533CF | 6x5 | 3 | 3/8 | 1.94 |
| 837-578C ¹ | 8x2 | 4-15/16 | 3-3/8 | 8.99 |
| 837-580C ¹ | 8x3 | 5-1/8 | 3-1/4 | 8.81 |
| 837-582C | 8x4 | 4-1/2 | 2-1/4 | 9.01 |
| 837-585C | 8x6 | 4-3/8 | 1-3/8 | 5.15 |
| 837-624C ¹ | 10x4 | 6 | 3-3/4 | 11.36 |
| 837-626C | 10x6 | 5-5/16 | 2-5/16 | 9.92 |
| 837-628C | 10x8 | 5-11/32 | 1-5/16 | 9.04 |
| 837-666CF | 12x6 | 6-7/16 | 3-3/8 | 19.45 |
| 837-668C | 12x8 | 6-7/8 | 2-7/16 | 10.82 |
| 837-670CF | 12x10 | 6-11/32 | 19/32 | 11.78 |
| 837-696CF | 14x6 | 7-3/4 | 4-3/4 | 37.74 |
| 837-698CF | 14x8 | 7-1/2 | 3-7/16 | 32.02 |
| 837-700CF | 14x10 | 7 | 2 | 22.64 |
| 837-702CF | 14x12 | 7 | 1 | 9.40 |
| 837-756CF | 16x6 | 8-3/4 | 5-3/4 | 67.03 |
| 837-758CF | 16x8 | 8-1/2 | 4-7/16 | 61.33 |
| 837-760CF | 16x10 | 8 | 3 | 44.88 |
| 837-762CF | 16x12 | 8 | 2 | 27.95 |
| 837-764CF | 16x14 | 8 | 1 | 20.00 |
| 837-788CF | 18x8 | 9-1/2 | 5-7/16 | --- |
| 837-790CF | 18x10 | 9 | 4 | 97.24 |

¹ Outlet sized with bushing



Schedule 80 CPVC Technical Information
Schedule 80 CPVC Fittings



Pumping&Plumbing

REDUCER BUSHING (continued)

Flush Style

Spigot x Socket

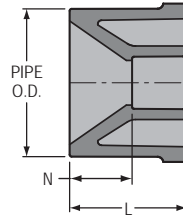

| Part Number | Size | L | N | Approx. Wt. (Lbs.) |
|-------------|-------|---|---|--------------------|
| 837-792CF | 18x12 | 9 | 3 | 84.92 |
| 837-794CF | 18x14 | 9 | 2 | 56.27 |
| 837-796CF | 18x16 | 9 | 1 | 34.00 |

REDUCER BUSHING

Flush Style

Spigot x Fipt

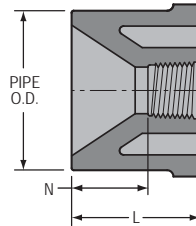

| Part Number | Size | L | N | Approx. Wt. (Lbs.) |
|-------------|-----------|---------|-------|--------------------|
| 838-052C | 3/8x1/4 | 31/32 | 3/8 | .01 |
| 838-071C | 1/2x1/8 | 1 | 9/16 | .02 |
| 838-072C | 1/2x1/4 | 1 | 7/8 | .02 |
| 838-073C | 1/2x3/8 | 1-3/32 | 17/32 | .02 |
| 838-098C | 3/4x1/4 | 1-7/32 | 5/8 | .04 |
| 838-099C | 3/4x3/8 | 1-1/4 | 21/32 | .04 |
| 838-101C | 3/4x1/2 | 1-7/32 | 15/32 | .03 |
| 838-129C | 1x3/8 | 1-13/32 | 19/32 | .07 |
| 838-130C | 1x1/2 | 1-5/32 | 21/32 | .06 |
| 838-131C | 1x3/4 | 1-3/8 | 21/32 | .06 |
| 838-166C | 1-1/4x1/2 | 1-17/32 | 3/4 | 12 |
| 838-167C | 1-1/4x3/4 | 1-7/16 | 23/32 | .10 |
| 838-168C | 1-1/4x1 | 1-17/32 | 5/8 | .09 |





Pumping&Plumbing

Schedule 80 CPVC Technical Information
Schedule 80 CPVC Fittings

REDUCER BUSHING (continued)

Flush Style

Spigot x Fipt

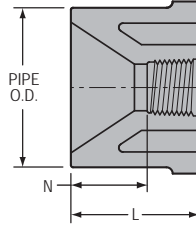

| Part Number | Size | L | N | Approx. Wt. (Lbs.) |
|-------------|-------------|---------|---------|--------------------|
| 838-207C | 1-1/2x1/4 | 1-9/16 | 1-3/16 | .14 |
| 838-209C | 1-1/2x1/2 | 1-11/16 | 31/32 | .17 |
| 838-210C | 1-1/2x3/4 | 1-9/16 | 27/32 | .18 |
| 838-211C | 1-1/2x1 | 1-23/32 | 13/16 | .16 |
| 838-212C | 1-1/2x1-1/4 | 1-1/2 | 9/16 | .10 |
| 838-247C | 2x1/2 | 1-29/32 | 1-5/32 | .27 |
| 838-248C | 2x3/4 | 1-7/8 | 1-5/32 | .27 |
| 838-249C | 2x1 | 1-29/32 | 1 | .27 |
| 838-250C | 2x1-1/4 | 1-19/32 | 21/32 | .25 |
| 838-251C | 2x1-1/2 | 1-9/16 | 5/8 | .20 |
| 838-287C | 2-1/2x1/2 | 2-3/8 | 1-21/32 | .46 |
| 838-288C | 2-1/2x3/4 | 2-7/16 | 1-5/8 | .48 |
| 838-289C | 2-1/2x1 | 2-5/32 | 1-1/4 | .48 |
| 838-290C | 2-1/2x1-1/4 | 2-13/32 | 1-3/8 | .45 |
| 838-291C | 2-1/2x1-1/2 | 2-3/8 | 1-13/32 | .50 |
| 838-292C | 2-1/2x2 | 2-1/16 | 1-1/16 | .33 |
| 838-334C | 3x3/4 | 2-9/32 | 1-1/2 | .63 |
| 838-335C | 3x1 | 2-9/32 | 1-11/32 | .63 |
| 838-336C | 3x1-1/4 | 2-1/4 | 1-3/8 | .61 |
| 838-337C | 3x1-1/2 | 2-1/4 | 1-5/8 | .62 |
| 838-338C | 3x2 | 2-3/16 | 1-7/32 | .58 |
| 838-339C | 3x2-1/2 | 2-3/8 | 3/4 | .50 |
| 838-420C | 4x2 | 2-11/16 | 1-21/32 | 1.20 |
| 838-421C | 4x2-1/2 | 2-21/32 | 1-1/16 | 1.15 |
| 838-422C | 4x3 | 2-5/8 | 1 | .85 |
| 838-528C | 6x2 | 3-17/32 | 2-1/2 | 3.04 |
| 838-530C | 6x3 | 3-17/32 | 2-1/8 | 3.14 |
| 838-532C | 6x4 | 3-17/32 | 2-1/32 | 2.68 |



Schedule 80 CPVC Technical Information
Schedule 80 CPVC Fittings



Pumping&Plumbing

**SPECIAL REINFORCED
REDUCER BUSHING**

Flush Style

Spigot x SR Fipt

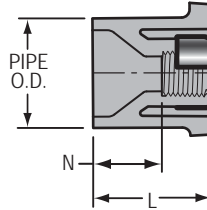

| Part Number | Size | L | N | Approx. Wt. (Lbs.) |
|-------------|-----------|---------|---------|--------------------|
| 838-128CSR | 1x1/4 | 1-13/32 | 25/32 | .08 |
| 838-207CSR | 1-1/2x1/4 | 1-9/16 | 1 | .14 |
| 838-209CSR | 1-1/2x1/2 | 1-23/32 | 31/32 | .18 |
| 838-210CSR | 1-1/2x3/4 | 1-9/16 | 13/16 | .15 |
| 838-247CSR | 2x1/2 | 1-29/32 | 1-5/32 | .25 |
| 838-248CSR | 2x3/4 | 1-29/32 | 1-5/32 | .28 |
| 838-249CSR | 2x1 | 1-7/8 | 31/32 | .27 |
| 838-334CSR | 3x3/4 | 2-9/32 | 1-17/32 | .63 |
| 838-335CSR | 3x1 | 2-9/32 | 1-11/32 | .63 |
| 838-336CSR | 3x1-1/4 | 2-1/4 | 1-5/16 | .63 |
| 838-337CSR | 3x1-1/2 | 2-1/4 | 1-3/8 | .64 |
| 838-528CSR | 6x2 | 3-1/2 | 2-9/16 | 2.96 |
| 838-530CSR | 6x3 | 3-17/32 | 2-1/8 | 3.07 |
| 838-532CSR | 6x4 | 3-1/2 | 1-15/16 | 2.62 |



REDUCER T.T. BUSHING

Flush Style

Mipt x Fipt

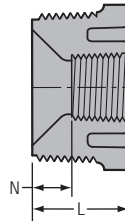

| Part Number | Size | L | N | Approx. Wt. (Lbs.) |
|-------------|---------|-------|-------|--------------------|
| 839-041C | 1/4x1/8 | 23/32 | 11/32 | .01 |
| 839-052C | 3/8x1/4 | 13/16 | 1/8 | .01 |



Pumping&Plumbing

Schedule 80 CPVC Technical Information
Schedule 80 CPVC Fittings

REDUCER T.T. BUSHING (continued)

Flush Style

Mipt x Fipt

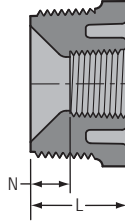

| Part Number | Size | L | N | Approx. Wt. (Lbs.) |
|-------------|-------------|---------|---------|--------------------|
| 839-072C | 1/2x1/4 | 29/32 | 9/32 | .02 |
| 839-073C | 1/2x3/8 | 15/16 | 11/32 | .01 |
| 839-098C | 3/4x1/4 | 1-1/32 | 7/16 | .04 |
| 839-099C | 3/4x3/8 | 1-1/32 | 7/16 | .03 |
| 839-101C | 3/4x1/2 | 15/16 | 3/16 | .02 |
| 839-128C | 1x1/4 | 1-1/8 | 17/32 | .06 |
| 839-129C | 1x3/8 | 1-7/32 | 5/8 | .06 |
| 839-130C | 1x1/2 | 1-1/16 | 5/16 | .06 |
| 839-131C | 1x3/4 | 1-1/8 | 13/32 | .04 |
| 839-166C | 1-1/4x1/2 | 1-5/16 | 9/16 | .11 |
| 839-167C | 1-1/4x3/4 | 1-9/32 | 9/16 | .09 |
| 839-168C | 1-1/4x1 | 1-9/32 | 1-1/32 | .06 |
| 839-209C | 1-1/2x1/2 | 1-11/32 | 19/32 | .13 |
| 839-210C | 1-1/2x3/4 | 1-11/32 | 19/32 | .13 |
| 839-211C | 1-1/2x1 | 1-11/32 | 13/32 | .11 |
| 839-212C | 1-1/2x1-1/4 | 1-11/32 | 13/32 | .07 |
| 839-247C | 2x1/2 | 1-3/8 | 21/32 | .18 |
| 839-248C | 2x3/4 | 1-3/8 | 5/8 | .18 |
| 839-249C | 2x1 | 1-3/8 | 15/32 | .19 |
| 839-250C | 2x1-1/4 | 1-3/8 | 7/16 | .17 |
| 839-251C | 2x1-1/2 | 1-3/8 | 13/32 | .13 |
| 839-292C | 2-1/2x2 | 1-29/32 | 7/8 | .23 |
| 839-337C | 3x1-1/2 | 1-15/16 | 29/32 | .52 |
| 839-338C | 3x2 | 1-15/16 | 15/16 | .47 |
| 839-339C | 3x2-1/2 | 1-15/16 | 5/8 | .39 |
| 839-420C | 4x2 | 2-1/8 | 1-1/8 | .87 |
| 839-422C | 4x3 | 2-1/8 | 1/2 | .74 |
| 839-532C | 6x4 | 3-17/32 | 1-13/16 | 2.78 |



Schedule 80 CPVC Technical Information
Schedule 80 CPVC Fittings



Pumping&Plumbing

**SPECIAL REINFORCED
REDUCER T.T. BUSHING**

Mipt x SR Fipt

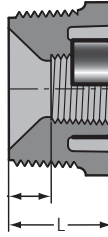

| Part Number | Size | L | N | Approx. Wt. (Lbs.) |
|-------------|-----------|---------|-------|--------------------|
| 839-209CSR | 1-1/2x1/2 | 1-11/32 | 19/32 | .13 |
| 839-210CSR | 1-1/2x3/4 | 1-11/32 | 19/32 | .13 |
| 839-247CSR | 2x1/2 | 1-3/8 | 21/32 | .19 |
| 839-248CSR | 2x3/4 | 1-3/8 | 5/8 | .19 |
| 839-249CSR | 2x1 | 1-3/8 | 15/32 | .20 |
| 839-420CSR | 4x2 | 2-1/8 | 1-1/8 | .91 |

CAP

Socket

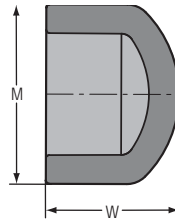

| Part Number | Size | M | W | Approx. Wt. (Lbs.) |
|-------------|-------|----------|---------|--------------------|
| 847-002C | 1/4 | 13/16 | 15/16 | .01 |
| 847-003C | 3/8 | 31/32 | 1-1/8 | .02 |
| 847-005C | 1/2 | 1-3/16 | 1-7/32 | .03 |
| 847-007C | 3/4 | 1-3/8 | 1-13/32 | .05 |
| 847-010C | 1 | 1-23/32 | 1-5/8 | .08 |
| 847-012C | 1-1/4 | 2-3/32 | 1-27/32 | .13 |
| 847-015C | 1-1/2 | 2-11/32 | 2 | .17 |
| 847-020C | 2 | 2-7/8 | 2-1/4 | .37 |
| 847-025C | 2-1/2 | 3-17/32 | 2-5/8 | .50 |
| 847-030C | 3 | 4-5/32 | 3-1/32 | .93 |
| 847-040C | 4 | 5-1/4 | 3-19/32 | 1.17 |
| 847-050CF | 5 | 6-1/2 | 4-7/16 | 5.28 |
| 847-060C | 6 | 7-1/2 | 4-7/8 | 3.30 |
| 847-080C | 8 | 9-23/32 | 6-3/8 | 6.36 |
| 847-100CF | 10 | 12-1/4 | 5-15/16 | 7.49 |
| 847-120CF | 12 | 14-1/4 | 7-1/8 | 11.72 |
| 847-140CF | 14 | 15-1/2 | 7-3/8 | 16.54 |
| 847-160CF | 16 | 17-7/8 | 9 | 24.52 |
| 847-180CF | 18 | 19-15/16 | 9-1/4 | 28.88 |
| 847-200CF | 20 | 22 | 14-1/4 | 52.00 |
| 847-240CF | 24 | 26-3/8 | 17-1/4 | 89.74 |



Pumping&Plumbing

Schedule 80 CPVC Technical Information
Schedule 80 CPVC Fittings

CAP
 Fipt

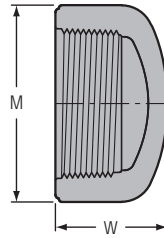

| Part Number | Size | M | W | Approx. Wt. (Lbs.) |
|-------------|-------|---------|---------|--------------------|
| 848-002C | 1/4 | 29/32 | 15/16 | .02 |
| 848-003C | 3/8 | 31/32 | 29/32 | .02 |
| 848-005C | 1/2 | 1-3/16 | 1-1/16 | .05 |
| 848-007C | 3/4 | 1-3/32 | 1-7/32 | .05 |
| 848-010C | 1 | 1-27/32 | 1-7/16 | .11 |
| 848-012C | 1-1/4 | 2-7/32 | 1-17/32 | .15 |
| 848-015C | 1-1/2 | 2-17/32 | 1-5/8 | .20 |
| 848-020C | 2 | 3-5/32 | 1-25/32 | .30 |
| 848-025C | 2-1/2 | 3-5/8 | 2-7/16 | .58 |
| 848-030C | 3 | 4-3/8 | 2-7/16 | .78 |
| 848-040C | 4 | 5-7/16 | 3-1/16 | 1.45 |
| 848-060CF | 6 | 7-3/16 | 4-3/8 | 6.18 |
| 848-080CF | 8 | 9-3/8 | 4-3/8 | 10.07 |
| 848-100CF | 10 | 11-5/8 | 5-3/4 | 7.69 |

SPECIAL REINFORCED CAP
 SR Fipt

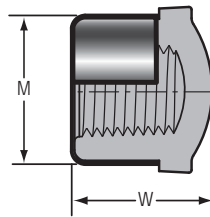

| Part Number | Size | M | W | Approx. Wt. (Lbs.) |
|-------------|------|--------|--------|--------------------|
| 848-002CSR | 1/4 | 27/32 | 27/32 | .02 |
| 848-003CSR | 3/8 | 31/32 | 29/32 | .03 |
| 848-005CSR | 1/2 | 1-3/16 | 1-1/8 | .05 |
| 848-007CSR | 3/4 | 1-3/8 | 1-3/32 | .06 |
| 848-030CSR | 3 | 4-9/32 | 2-7/16 | .84 |

Schedule 80 CPVC Technical Information
Schedule 80 CPVC Fittings



Pumping&Plumbing

PLUG
 Spigot

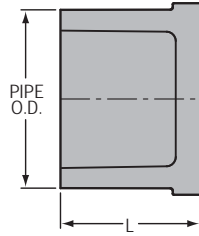

| Part Number | Size | L | Approx. Wt. (Lbs.) |
|-------------|-------|----------|--------------------|
| 849-005C | 1/2 | 1-1/8 | .03 |
| 849-007C | 3/4 | 1-1/4 | .04 |
| 849-010C | 1 | 1-3/8 | .07 |
| 849-020C | 2 | 1-7/8 | .22 |
| 849-025CF | 2-1/2 | 5-3/8 | 1.17 |
| 849-030CF | 3 | 5-5/8 | 1.42 |
| 849-040CF | 4 | 6-1/2 | 3.00 |
| 849-060CF | 6 | 9 | 8.59 |
| 849-080CF | 8 | 11-3/8 | 13.50 |
| 849-100CF | 10 | 11-15/16 | 19.14 |
| 849-120CF | 12 | 14-1/8 | 31.17 |



PLUG
 Mipt

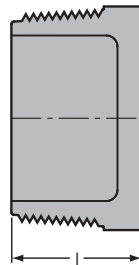

| Part Number | Size | L | Approx. Wt. (Lbs.) |
|-------------|-------|---------|--------------------|
| 850-002C | 1/4 | 23/32 | .01 |
| 850-003C | 3/8 | 13/16 | .01 |
| 850-005C | 1/2 | 13/16 | .02 |
| 850-007C | 3/4 | 7/8 | .03 |
| 850-010C | 1 | 1-1/4 | .06 |
| 850-012C | 1-1/4 | 1-9/32 | .08 |
| 850-015C | 1-1/2 | 1-11/32 | .11 |
| 850-020C | 2 | 1-3/8 | .20 |
| 850-025C | 2-1/2 | 1-25/32 | .33 |
| 850-030C | 3 | 1-7/8 | .45 |
| 850-040C | 4 | 2-3/32 | .79 |
| 850-060C | 6 | 2-3/32 | 1.80 |
| 850-080CF | 8 | 8-5/8 | 12.39 |
| 850-100CF | 10 | 8-7/16 | 13.76 |



Pumping & Plumbing

Schedule 80 CPVC Technical Information
Schedule 80 CPVC Fittings

WYE

Socket x Socket x Socket

1/2" - 2" 235 psi @ 73°F
 2-1/2" - 6" 150 psi @ 73°F
 8" & Up & All Fab 100 psi @ 73°F

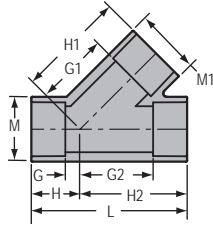

| Part Number | Size | G | G1 | G2 | H | H1 | H2 | L | M | M1 | Approx. Wt. (Lbs.) |
|-------------|-------|---------|----------|----------|----------|----------|----------|----------|----------|----------|--------------------|
| 875-005C | 1/2 | 1/4 | 1-5/32 | 1-5/32 | 1-1/8 | 2-1/16 | 2-1/32 | 3-3/16 | 1-5/32 | 1-5/32 | .13 |
| 875-007C | 3/4 | 5/16 | 1-3/8 | 1-3/8 | 1-5/16 | 2-3/8 | 2-3/8 | 3-23/32 | 1-3/8 | 1-3/8 | .20 |
| 875-010C | 1 | 5/16 | 1-3/4 | 1-3/4 | 1-7/16 | 2-29/32 | 2-7/8 | 4-11/32 | 1-11/16 | 1-11/16 | .33 |
| 875-012C | 1-1/4 | 13/32 | 2-5/32 | 2-5/32 | 1-21/32 | 3-13/32 | 3-13/32 | 5-3/32 | 2-1/16 | 2-1/16 | .53 |
| 875-015C | 1-1/2 | 17/32 | 2-1/2 | 2-1/2 | 1-29/32 | 3-7/8 | 3-7/8 | 5-13/16 | 2-5/16 | 2-5/16 | .74 |
| 875-020C | 2 | 5/8 | 3-7/32 | 3-7/32 | 2-5/32 | 4-7/8 | 4-7/8 | 6-7/8 | 2-7/8 | 2-7/8 | 1.28 |
| 875-025C | 2-1/2 | 27/32 | 3-31/32 | 3-31/32 | 2-19/32 | 5-23/32 | 5-23/32 | 8-5/16 | 3-1/2 | 3-1/2 | 2.08 |
| 875-030C | 3 | 31/32 | 4-3/4 | 4-25/32 | 2-27/32 | 6-5/8 | 6-21/32 | 9-1/2 | 4-3/16 | 4-3/16 | 3.12 |
| 875-040C | 4 | 1-1/4 | 6-1/32 | 6-1/32 | 3-1/2 | 8-9/32 | 8-9/32 | 11-25/32 | 5-1/4 | 5-1/4 | 5.31 |
| 875-060C | 6 | 1-5/32 | 8-25/32 | 8-3/16 | 4-3/16 | 11-25/32 | 11-3/16 | 15-3/8 | 7-9/16 | 7-9/16 | 12.67 |
| 875-080C | 8 | 1-15/16 | 11-11/32 | 11-11/32 | 5-31/32 | 15-11/32 | 15-11/32 | 21-5/16 | 9-3/4 | 9-3/4 | 26.97 |
| 875-080CF | 8 | 5-1/16 | 15-7/8 | 13-11/16 | 9-5/16 | 20-1/8 | 17-15/16 | 27-1/4 | 9-5/8 | 9-5/8 | 44.67 |
| 875-100CF | 10 | 6-1/2 | 18-7/8 | 17-1/4 | 11-3/4 | 24-1/8 | 22-1/2 | 34-1/4 | 11-15/16 | 11-15/16 | 75.04 |
| 875-120CF | 12 | 7-1/8 | 21-13/16 | 19-7/8 | 13-3/8 | 28-1/16 | 26-1/8 | 39-1/2 | 14-1/8 | 14-1/8 | 123.20 |
| 875-140CF | 14 | 9-13/16 | 23-13/16 | 23-13/16 | 16-13/16 | 30-13/16 | 30-13/16 | 47-5/8 | 15-1/2 | 15-1/2 | 149.48 |
| 875-160CF | 16 | 10-1/8 | 26-1/8 | 26-1/8 | 18-1/8 | 34-1/8 | 34-1/8 | 52-1/4 | 17-11/16 | 17-11/16 | 211.73 |
| 875-180CF | 18 | 10 | 29-3/8 | 28 | 19 | 38-3/8 | 37 | 56 | 19-7/8 | 19-7/8 | 292.04 |

REDUCING WYE

Socket x Socket x Socket

1/2" - 2-1/2" 235 psi @ 73°F
 3" - 6" 150 psi @ 73°F
 8" & Up & All Fab 100 psi @ 73°F

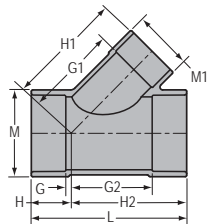

| Part Number | Size | G | G1 | G2 | H | H1 | H2 | L | M | M1 | Approx. Wt. (Lbs.) |
|-----------------------|-------------------|-----|--------|--------|--------|--------|---------|---------|---------|---------|--------------------|
| 875-167C ¹ | 1-1/4x1-1/4x3/4 | 3/8 | 2-3/4 | 2-1/4 | 1-5/8 | 3-3/4 | 3-1/2 | 5-1/8 | 2-1/16 | 2-1/16 | .65 |
| 875-168C ¹ | 1-1/4x1-1/4x1 | 3/8 | 2-5/8 | 2-1/4 | 1-5/8 | 3-3/4 | 3-1/2 | 5-1/8 | 2-1/16 | 2-1/16 | .62 |
| 875-210C ¹ | 1-1/2x1-1/2x3/4 | 1/2 | 3-1/2 | 2-9/16 | 1-7/8 | 4-1/2 | 3-15/16 | 5-13/16 | 2-11/32 | 2-11/32 | .94 |
| 875-211C ¹ | 1-1/2x1-1/2x1 | 1/2 | 3 | 2-9/16 | 1-7/8 | 4-5/32 | 3-15/16 | 5-13/16 | 2-11/32 | 2-11/32 | .89 |
| 875-212C ¹ | 1-1/2x1-1/2x1-1/4 | 1/2 | 3-1/4 | 2-9/16 | 1-7/8 | 4-1/2 | 3-15/16 | 5-13/16 | 2-11/32 | 2-11/32 | .82 |
| 875-248C ¹ | 2x2x3/4 | 5/8 | 4-5/32 | 3-7/32 | 2-5/32 | 5-5/32 | 4-7/8 | 6-7/8 | 2-7/8 | 2-7/8 | 1.56 |

¹Outlet sized with bushing

Schedule 80 CPVC Technical Information
Schedule 80 CPVC Fittings



Pumping&Plumbing

REDUCING WYE (continued)
 Socket x Socket x Socket

1/2" - 2-1/2" 235 psi @ 73°F
 3" - 6" 150 psi @ 73°F
 8" & Up & All Fab 100 psi @ 73°F

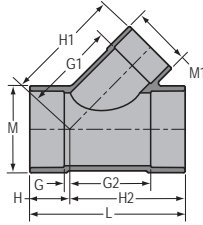

| Part Number | Size | G | G1 | G2 | H | H1 | H2 | L | M | M1 | Approx. Wt. (Lbs.) |
|-----------------------|-----------|---------|----------|---------|---------|----------|----------|----------|----------|----------|--------------------|
| 875-250C ¹ | 2x2x1-1/4 | 5/8 | 3-5/16 | 3-3/8 | 2-5/32 | 5 | 4-3/4 | 6-7/8 | 2-7/8 | 2-7/8 | 1.52 |
| 875-251C ¹ | 2x2x1-1/2 | 1/2 | 3-23/32 | 3-11/32 | 2-1/32 | 5-3/32 | 4-7/8 | 6-7/8 | 2-7/8 | 2-7/8 | 1.44 |
| 875-335C ¹ | 3x3x1 | 11/16 | 5-7/8 | 4-7/32 | 2-9/16 | 6-15/16 | 6-1/8 | 8-23/32 | 4-3/16 | 4-3/16 | 3.57 |
| 875-336C ¹ | 3x3x1-1/4 | 7/8 | 5-3/4 | 4-1/8 | 2-3/4 | 7 | 6 | 8-3/4 | 4-3/16 | 4-3/16 | 3.34 |
| 875-337C ¹ | 3x3x1-1/2 | 2-5/8 | 5-1/2 | 4-1/4 | 2-5/8 | 6-7/8 | 6-1/8 | 8-3/4 | 4-3/16 | 4-3/16 | 3.21 |
| 875-338C ¹ | 3x3x2 | 1 | 5-11/32 | 4-3/4 | 2-7/8 | 6-31/32 | 6-5/8 | 9-1/2 | 4-3/16 | 4-3/16 | 3.21 |
| 875-339C ¹ | 3x3x2-1/2 | 7/8 | 4-1/8 | 4-21/32 | 2-3/4 | 6-3/4 | 6 | 8-3/4 | 4-3/16 | 4-3/16 | 3.11 |
| 875-420C | 4x4x2 | -7/8 | 5-5/32 | 4-11/16 | 1-3/8 | 6-11/16 | 6-15/16 | 8-5/16 | 5-9/32 | 2-29/32 | 2.92 |
| 875-422C | 4x4x3 | 1/2 | 5-7/16 | 5-7/32 | 2-3/4 | 7-5/16 | 7-15/32 | 10-7/32 | 5-1/4 | 4-3/16 | 4.18 |
| 875-528C ¹ | 6x6x2 | 1/16 | 8-13/16 | 6-9/16 | 3-1/16 | 10-5/16 | 9-9/16 | 12-5/8 | 7-9/16 | 5-7/16 | 10.10 |
| 875-528CF | 6x6x2 | 1-15/16 | 9-3/16 | 8-9/16 | 5-3/16 | 10-15/16 | 11-13/16 | 17 | 7-1/2 | 2-13/16 | 10.07 |
| 875-530C ¹ | 6x6x3 | -1/16 | 8-3/8 | 6-11/16 | 3 | 10-1/4 | 9-11/16 | 12-5/8 | 7-9/16 | 5-3/8 | 9.82 |
| 875-530CF | 6x6x3 | 2-15/16 | 10-5/16 | 9-9/16 | 6-3/16 | 12-9/16 | 12-13/16 | 19 | 7-1/2 | 4-1/8 | 12.14 |
| 875-532C | 6x6x4 | 31/32 | 6-9/16 | 5-11/16 | 3-15/16 | 8-27/32 | 8-23/32 | 12-21/32 | 7-9/16 | 5-7/16 | 9.22 |
| 875-578C ¹ | 8x8x2 | 2 | 14-15/16 | 11-1/4 | 6 | 16-9/16 | 16-7/16 | 21-1/4 | 9-11/16 | 9-11/16 | 35.44 |
| 875-578CF | 8x8x2 | 7/8 | 10-1/2 | 9-1/2 | 5-1/8 | 12-1/4 | 13-3/4 | 18-7/8 | 9-5/8 | 2-13/16 | 19.12 |
| 875-579CF | 8x8x2-1/2 | 1-7/16 | 10-15/16 | 10-1/16 | 5-11/16 | 12-15/16 | 14-5/16 | 20 | 9-5/8 | 3-7/16 | 22.00 |
| 875-580CF | 8x8x3 | 1-15/16 | 11-5/8 | 10-9/16 | 6-3/16 | 13-7/8 | 14-13/16 | 21 | 9-5/8 | 4-1/8 | 18.87 |
| 875-582C | 8x8x4 | 11/16 | 9-1/8 | 8-3/16 | 3-5/16 | 11-3/8 | 12-3/16 | 15-1/2 | 9-23/32 | 5-1/4 | 14.98 |
| 875-582CF | 8x8x4 | 2-15/16 | 11-7/8 | 11-9/16 | 7-3/16 | 14-1/8 | 15-13/16 | 23 | 9-5/8 | 5-3/16 | 27.78 |
| 875-585C ¹ | 8x8x6 | 2 | 12-15/16 | 11-1/4 | 6 | 15-15/16 | 15-1/4 | 21-1/4 | 9-11/16 | 9-11/16 | 32.29 |
| 875-585CF | 8x8x6 | 4-15/16 | 13-15/16 | 13-9/16 | 9-3/16 | 17-3/16 | 17-13/16 | 27 | 9-5/8 | 7-1/2 | 34.75 |
| 875-621CF | 10x10x2 | 1/4 | 11-7/8 | 10-1/2 | 5 | 13-5/8 | 15-3/4 | 20-3/4 | 11-15/16 | 2-13/16 | 26.48 |
| 875-623CF | 10x10x3 | 3/4 | 13 | 11-1/2 | 6 | 15-1/4 | 16-3/4 | 22-3/4 | 11-15/16 | 4-1/8 | 29.62 |
| 875-624CF | 10x10x4 | 1-3/4 | 13-1/4 | 12-1/2 | 7 | 15-1/2 | 17-3/4 | 24-3/4 | 11-15/16 | 5-3/16 | 39.21 |
| 875-626C | 10x10x6 | -3/16 | 12 | 11 | 4-13/16 | 15 | 16 | 20-25/32 | 12-1/16 | 7-21/32 | 29.85 |
| 875-626CF | 10x10x6 | 3-3/4 | 15-5/16 | 14-1/2 | 9 | 18-9/16 | 19-3/4 | 28-3/4 | 11-15/16 | 7-1/2 | 29.74 |
| 875-628C | 10x10x8 | 1-7/32 | 12-3/4 | 12-1/4 | 6-7/32 | 16-25/32 | 17-9/32 | 23-1/2 | 12-1/32 | 9-23/32 | 38.99 |
| 875-628CF | 10x10x8 | 5-1/4 | 17-1/4 | 16 | 10-1/2 | 21-1/2 | 21-1/4 | 31-3/4 | 11-15/16 | 9-5/8 | 56.37 |
| 875-661CF | 12x12x2 | 1-5/16 | 13-3/16 | 11-7/16 | 4-15/16 | 14-15/16 | 17-11/16 | 22-5/8 | 14-1/8 | 2-13/16 | 40.76 |
| 875-663CF | 12x12x3 | 1/8 | 14-5/16 | 12-7/8 | 6-3/8 | 16-9/16 | 19-1/8 | 25-1/2 | 14-1/8 | 4-1/8 | 44.74 |
| 875-664CF | 12x12x4 | 5/8 | 14-9/16 | 13-3/8 | 6-7/8 | 16-13/16 | 19-5/8 | 26-1/2 | 14-1/8 | 5-3/16 | 49.06 |
| 875-666CF | 12x12x6 | 2-5/8 | 16-5/8 | 15-3/8 | 8-7/8 | 19-7/8 | 21-5/8 | 30-1/2 | 14-1/8 | 7-1/2 | 58.24 |
| 875-668CF | 12x12x8 | 4-1/4 | 18-9/16 | 17 | 10-1/2 | 22-13/16 | 23-1/4 | 33-3/4 | 14-1/8 | 9-5/8 | 68.98 |
| 875-670CF | 12x12x10 | 5-3/4 | 20-3/16 | 18-1/2 | 12 | 25-7/16 | 24-3/4 | 36-3/4 | 14-1/8 | 11-15/16 | 81.76 |
| 875-694CF | 14x14x4 | 1-1/4 | 15-5/16 | 15-1/4 | 8-1/4 | 17-9/16 | 22-1/4 | 30-1/2 | 15-1/2 | 5-3/16 | 63.95 |
| 875-696CF | 14x14x6 | 2 | 17-3/8 | 16 | 9 | 20-5/8 | 23 | 32 | 15-1/2 | 7-1/2 | 83.85 |

¹ Outlet sized with bushing





Pumping & Plumbing

Schedule 80 CPVC Technical Information
Schedule 80 CPVC Fittings

REDUCING WYE (continued)

Socket x Socket x Socket

1/2" - 2-1/2" 235 psi @ 73°F
 3" - 6" 150 psi @ 73°F
 8" & Up & All Fab 100 psi @ 73°F

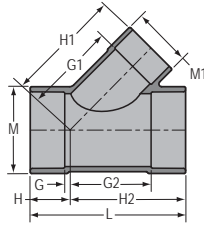

| Part Number | Size | G | G1 | G2 | H | H1 | H2 | L | M | M1 | Approx. Wt. (Lbs.) |
|-------------|----------|-------|----------|---------|--------|----------|---------|----------|----------|----------|--------------------|
| 875-698CF | 14x14x8 | 4-1/4 | 19-5/16 | 18-1/4 | 11-1/4 | 23-9/16 | 25-1/4 | 36-1/2 | 15-1/2 | 9-5/8 | 82.78 |
| 875-700CF | 14x14x10 | 5-3/4 | 20-15/16 | 19-3/4 | 12-3/4 | 26-3/16 | 26-3/4 | 39-1/2 | 15-1/2 | 11-15/16 | 107.47 |
| 875-702CF | 14x14x12 | 7-1/4 | 22-9/16 | 21-1/4 | 14-1/4 | 28-13/16 | 28-1/4 | 42-1/2 | 15-1/2 | 14-1/8 | 115.64 |
| 875-754CF | 16x16x4 | 1-1/8 | 16-5/8 | 17-1/8 | 9-1/8 | 18-7/8 | 25-1/8 | 34-1/4 | 17-11/16 | 5-3/16 | 88.48 |
| 875-756CF | 16x16x6 | 1-5/8 | 18-11/16 | 17-5/8 | 9-5/8 | 21-15/16 | 25-5/8 | 35-1/4 | 17-11/16 | 7-1/2 | 94.93 |
| 875-758CF | 16x16x8 | 3-5/8 | 20-5/8 | 19-5/8 | 11-5/8 | 24-7/8 | 27-5/8 | 39-1/4 | 17-11/16 | 9-5/8 | 108.85 |
| 875-760CF | 16x16x10 | 5-1/8 | 22-1/4 | 21-1/8 | 13-1/8 | 27-1/2 | 29-1/8 | 42-1/4 | 17-11/16 | 11-15/16 | 137.97 |
| 875-762CF | 16x16x12 | 6-1/2 | 23-7/8 | 22-1/2 | 14-1/2 | 30-1/8 | 30-1/2 | 45 | 17-11/16 | 14-1/8 | 146.49 |
| 875-764CF | 16x16x14 | 7-7/8 | 25-1/8 | 23-7/8 | 15-7/8 | 32-1/8 | 31-7/8 | 47-3/4 | 17-11/16 | 15-1/2 | 167.10 |
| 875-784CF | 18x18x4 | 0 | 17-7/8 | 18 | 9 | 20-1/8 | 27 | 36 | 19-7/8 | 5-3/16 | 119.05 |
| 875-786CF | 18x18x6 | 3/8 | 20-1/8 | 18-9/16 | 9-3/8 | 23-3/8 | 27-9/16 | 36-15/16 | 19-7/8 | 7-1/2 | 131.59 |
| 875-788CF | 18x18x8 | 3 | 21-7/8 | 21 | 12 | 26-1/8 | 30 | 42 | 19-7/8 | 9-5/8 | 146.16 |
| 875-790CF | 18x18x10 | 4-1/2 | 23-1/2 | 22-1/2 | 13-1/2 | 28-3/4 | 31-1/2 | 45 | 19-7/8 | 11-15/16 | 163.18 |
| 875-792CF | 18x18x12 | 6 | 25-1/8 | 24 | 15 | 31-3/8 | 33 | 48 | 19-7/8 | 14-1/8 | 184.28 |
| 875-794CF | 18x18x14 | 7 | 26-3/8 | 25 | 16 | 33-3/8 | 34 | 50 | 19-7/8 | 15-1/2 | 211.65 |
| 875-796CF | 18x18x16 | 8-1/2 | 27-3/8 | 26-1/2 | 17-1/2 | 35-3/8 | 35-1/2 | 53 | 19-7/8 | 17-11/16 | 243.00 |
| 875-822CF | 20x20x12 | 5-5/8 | 26-7/16 | 25-5/8 | 15-5/8 | 32-11/16 | 35-5/8 | 51-1/4 | 22-1/16 | 14-1/8 | 213.90 |
| 875-824CF | 20x20x14 | 7-1/8 | 27-11/16 | 27-1/8 | 17-1/8 | 34-11/16 | 37-1/8 | 54-1/4 | 22-1/16 | 15-1/2 | 239.07 |
| 875-826CF | 20x20x16 | 8-1/2 | 28-11/16 | 28-1/2 | 18-1/2 | 36-11/16 | 38-1/2 | 57 | 22-1/16 | 17-11/16 | 321.08 |
| 875-904CF | 24x24x4 | 3 | 21-3/4 | 21 | 9 | 24 | 33 | 42 | 26-7/16 | 5-3/16 | 251.85 |

¹Outlet sized with bushing

DOUBLE WYE

Socket x Socket x Socket x Socket

100 psi @ 73°F

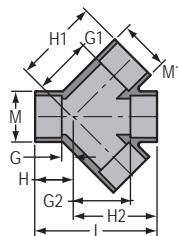

| Part Number | Size | G | G1 | G2 | H | H1 | H2 | L | M | M1 | Approx. Wt. (Lbs.) |
|-------------|------|---------|----------|----------|---------|---------|----------|----------|----------|----------|--------------------|
| 876-020CF | 2 | 3-7/8 | 6-1/4 | 6-1/4 | 5-7/16 | 7-13/16 | 7-13/16 | 13-3/16 | 2-7/8 | 2-7/8 | 3.01 |
| 876-030CF | 3 | 4-3/4 | 8-1/8 | 8-1/4 | 6-5/8 | 10-3/16 | 10-3/16 | 16-13/16 | 4-3/16 | 4-3/16 | 5.84 |
| 876-040CF | 4 | 4-11/16 | 9-3/16 | 9-3/16 | 6-15/16 | 11-7/16 | 11-7/16 | 18-3/8 | 5-3/16 | 5-3/16 | 13.33 |
| 876-060CF | 6 | 4-15/16 | 12-5/8 | 11-9/16 | 8-3/16 | 15-7/8 | 14-13/16 | 23 | 7-1/2 | 7-1/2 | 28.16 |
| 876-080CF | 8 | 5-1/16 | 15-7/8 | 13-11/16 | 9-5/16 | 20-1/8 | 17-15/16 | 27-1/4 | 9-5/8 | 9-5/8 | 55.13 |
| 876-100CF | 10 | 6-1/2 | 18-7/8 | 17-1/4 | 11-3/4 | 24-1/8 | 22-1/2 | 34-1/4 | 11-15/16 | 11-15/16 | 94.00 |
| 876-120CF | 12 | 7-1/8 | 21-13/16 | 19-7/8 | 13-3/8 | 28-1/16 | 26-1/8 | 39-1/2 | 14-1/8 | 14-1/8 | 149.15 |

Schedule 80 CPVC Technical Information
Schedule 80 CPVC Fittings



Pumping&Plumbing

REDUCING DOUBLE WYE

Socket x Socket x Socket x Socket

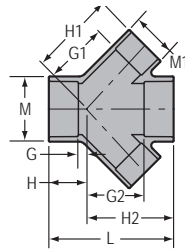

3" - 6" 150 psi @ 73°F
 All Fab 100 psi @ 73°F

| Part Number | Size | G | G1 | G2 | H | H1 | H2 | L | M | M1 | Approx. Wt. (Lbs.) |
|-------------|----------|---------|----------|----------|---------|----------|----------|--------|----------|----------|--------------------|
| 876-338C | 3x2 | 3/8 | 4-1/4 | 4-13/32 | 2-1/4 | 5-3/4 | 5-29/32 | 8 | 4-3/16 | 2-7/8 | 2.24 |
| 876-421CF | 4x2-1/2 | 4-9/16 | 8-13/16 | 9-1/16 | 6-13/16 | 10-1/2 | 11-5/16 | 18-1/8 | 5-1/4 | 3-1/2 | 6.00 |
| 876-422CF | 4x3 | 4-11/16 | 10 | 9-3/16 | 6-15/16 | 11-13/16 | 11-7/16 | 18-3/8 | 5-3/16 | 5-3/16 | 14.00 |
| 876-528CF | 6x2 | 1-15/16 | 9-3/16 | 8-9/16 | 5-3/16 | 10-15/16 | 11-13/16 | 17 | 7-1/2 | 2-13/16 | 11.45 |
| 876-529CF | 6x2-1/2 | 2-7/16 | 9-5/8 | 9-1/16 | 5-11/16 | 11-5/8 | 12-5/16 | 18 | 7-1/2 | 3-7/16 | 14.00 |
| 876-530CF | 6x3 | 2-15/16 | 10-15/16 | 9-9/16 | 6-3/16 | 12-9/16 | 12-13/16 | 19 | 7-1/2 | 4-1/8 | 12.14 |
| 876-532CF | 6x4 | 3-15/16 | 10-9/16 | 10-9/16 | 7-3/16 | 12-13/16 | 13-13/16 | 21 | 7-1/2 | 5-3/16 | 19.78 |
| 876-578CF | 8x2 | 7/8 | 10-1/2 | 9-1/2 | 5-1/8 | 12-1/4 | 13-3/4 | 18-7/8 | 9-5/8 | 2-13/16 | 19.56 |
| 876-579CF | 8x2-1/2 | 1-7/16 | 10-15/16 | 10-1/16 | 5-11/16 | 12-15/16 | 14-5/16 | 20 | 9-5/8 | 3-7/16 | 22.00 |
| 876-580CF | 8x3 | 1-15/16 | 11-5/8 | 10-9/16 | 6-3/16 | 13-7/8 | 14-13/16 | 21 | 9-5/8 | 4-1/8 | 21.92 |
| 876-582CF | 8x4 | 2-15/16 | 11-7/8 | 11-9/16 | 7-3/16 | 14-1/8 | 15-13/16 | 23 | 9-5/8 | 5-3/16 | 24.78 |
| 876-585CF | 8x6 | 4-15/16 | 13-15/16 | 13-9/16 | 9-3/16 | 17-3/16 | 17-13/16 | 27 | 9-5/8 | 7-1/2 | 41.48 |
| 876-621CF | 10x2 | 1/4 | 11-7/8 | 10-1/2 | 5 | 13-5/8 | 15-3/4 | 20-3/4 | 11-15/16 | 2-13/16 | 26.98 |
| 876-622CF | 10x2-1/2 | 1/8 | 12-5/16 | 10-7/8 | 5-3/8 | 14-5/16 | 16-1/8 | 21-1/2 | 11-15/16 | 3-7/16 | 32.27 |
| 876-623CF | 10x3 | 3/4 | 13 | 11-1/2 | 6 | 15-1/4 | 16-3/4 | 22-3/4 | 11-15/16 | 4-1/8 | 29.62 |
| 876-624CF | 10x4 | 1-3/4 | 13-1/4 | 12-1/2 | 7 | 15-1/2 | 17-3/4 | 24-3/4 | 11-15/16 | 5-3/16 | 34.22 |
| 876-626CF | 10x6 | 3-3/4 | 15-5/16 | 14-1/2 | 9 | 18-9/16 | 19-3/4 | 28-3/4 | 11-15/16 | 7-1/2 | 46.55 |
| 876-628CF | 10x8 | 5-1/4 | 17-1/4 | 16 | 10-1/2 | 21-1/2 | 21-1/4 | 31-3/4 | 11-15/16 | 9-5/8 | 60.66 |
| 876-661CF | 12x2 | 1-5/16 | 13-3/16 | 11-7/16 | 4-15/16 | 14-15/16 | 17-11/16 | 22-5/8 | 14-1/8 | 2-13/16 | 40.76 |
| 876-662CF | 12x2-1/2 | 15/16 | 13-5/8 | 11-13/16 | 5-5/16 | 15-5/8 | 18-1/16 | 23-3/8 | 14-1/8 | 3-7/16 | 55.95 |
| 876-663CF | 12x3 | 1/8 | 14-5/16 | 12-7/8 | 6-3/8 | 16-9/16 | 19-1/8 | 25-1/2 | 14-1/8 | 4-1/8 | 44.74 |
| 876-664CF | 12x4 | 5/8 | 14-9/16 | 13-3/8 | 6-7/8 | 16-13/16 | 19-5/8 | 26-1/2 | 14-1/8 | 5-3/16 | 49.06 |
| 876-666CF | 12x6 | 2-5/8 | 16-5/8 | 15-3/8 | 8-7/8 | 19-7/8 | 21-5/8 | 30-1/2 | 14-1/8 | 7-1/2 | 58.24 |
| 876-668CF | 12x8 | 4-1/4 | 18-9/16 | 17 | 10-1/2 | 22-13/16 | 23-1/4 | 33-3/4 | 14-1/8 | 9-5/8 | 86.23 |
| 876-670CF | 12x10 | 5-3/4 | 20-3/16 | 18-1/2 | 12 | 25-7/16 | 24-3/4 | 36-3/4 | 14-1/8 | 11-15/16 | 100.26 |

